

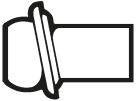

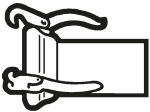

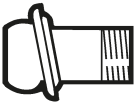

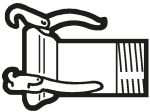



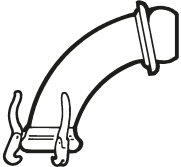



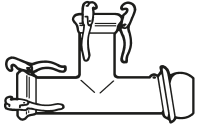

**Accessori per pompe e
impianti wellpoint**
**Accessories for pumps and
wellpoint system**
**Accesorios para bombas y
instalaciones wellpoint**

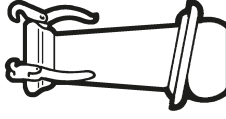

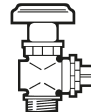



Descrizione Description Descripción		Materiale Material Material	Note Notes Notas	Codice Code Código	Peso Weight Peso	Lunghezza Length Longitud	Diametro Diameter Diámetro	Conessioni Connections Conexiones	
					[kg]	[mm]	[mm / in]	[mm]	[in]
N° 1 Raccordo portagomma maschio Male hose fitting Racor macho para manguera		Acciaio zincato Galvanized steel Acero galvanizado		10013367	0,4	110	40	50	2"
				10013368	0,6	130	50		
				10013369	0,8	140	60		
				10013371	1,3	230	80		
				10013374	1,7	280	100		
				10013376	2,8	290	120		
				10013377	3,5	295	150		
				10013379	8	355	200		
				10013380	12	400	250		
				10013381	24	505	300		
N° 2 Raccordo portagomma femmina Female hose fitting Racor hembra para manguera		Acciaio zincato Galvanized steel Acero galvanizado		10013349	0,8	105	40	50	2"
				10013350	1,3	140	50		
				10013351	1,4	150	60		
				10013354	1,5	225	80		
				10013357	2,0	240	80		
				10013356	2,3	250	100		
				10013359	3,0	255	120		
				10013360	3,6	260	150		
				10013363	9	300	200		
				10013365	11	340	250		
N° 3 Raccordo maschio filettato Threaded male coupling Racor macho roscado		Acciaio zincato Galvanized steel Acero galvanizado		10013311	0,3	60	1 1/4"	50	2"
				10013312	0,4	70	1 1/2"		
				10013313	0,5	85	2"		
				10013316	1,4	145	3"		
				10013318	1,9	150	4"		
				10013324	3,0	190	5"		
				10013326	3,5	170	5"		
				10018445	3,8	180	6"		
N° 4 Raccordo femmina filettato Threaded female coupling Racor hembra roscado		Acciaio zincato Galvanized steel Acero galvanizado		10013302	0,7	75	1 1/4"	50	2"
				10013301	0,9	80	1 1/2"		
				10013303	1	100	2"		
				10013304	1,7	110	3"		
				10013307	2,1	115	4"		
				10013308	3,2	125	5"		
				10013310	4	140	6"		

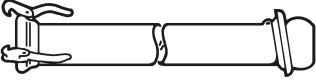

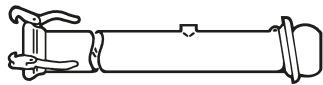
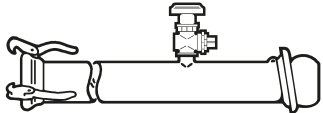
Descrizione Description Descripción		Materiale Material Material	Note Notes Notas	Codice Code Código	Peso Weight Peso	Lunghezza Length Longitud	Diametro Diameter Diámetro	Connessioni Connections Conexiones	
					[kg]	[mm]	[mm / in]	[mm]	[in]
N° 5 Raccordo maschio flangiato Flanged male coupling Racor de brida macho		Acciaio zincato Galvanized steel Acero galvanizado	**EN 1092-1 PN 10/16 *Ø 150 fresato with cut fresado	10013331	1,5	50	-	50	2"
				10013314	5	100		80	3"
				10013332	6	120		100	4"
				10013335	8	180		150	6"
				**10013336	10	205			
				*10013338	8	180		200	8"
				10013344	10	255			
				10013347	20	315		250	10"
				10013348	30	380		300	12"
				N° 6 Curva a 45° 45° elbow Curva 45°		Acciaio zincato Galvanized steel Acero galvanizado			10013396
10013397	3,4	100	4"						
10013398	4,5	120	5"						
10013399	6	150	6"						
10013401	15	200	8"						
10013402	22	250	10"						
N° 7 Curva a 90° 90° elbow Curva 90°		Acciaio zincato Galvanized steel Acero galvanizado		10013404	1,7	-	-	50	2"
				10013405	2,7			80	3"
				10013407	4			100	4"
				10013409	7			120	5"
				10013410	7,5			150	6"
				10022355	16			200	8"
				10047781	24			250	10"
				10013419	42			300	12"
N° 8 Tappo maschio Male cap Tapón macho		Acciaio zincato Galvanized steel Acero galvanizado		10013462	1,4	-	-	100	4"
				10013463	2			120	5"
				10013464	2,9			150	6"
				10013465	7			200	8"
				10021960	11			250	10"
				N° 9 Tappo femmina Female cap Tapón hembra				Acciaio zincato Galvanized steel Acero galvanizado	
10013457	1,4	100	4"						
10013458	1,9	120	5"						
10013459	2,3	150	6"						
10013460	7	200	8"						
10021959	11	250	10"						
N° 10 Tappo filettato Threaded plug Tapón roscado		Acciaio zincato Galvanized steel Acero galvanizado		10002383	0,2	-	-	32	1 1/4"



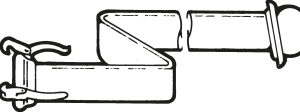
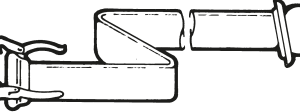

Descrizione Description Descripción		Materiale Material Material	Note Notes Notas	Codice Code Código	Peso Weight Peso	Lunghezza Lenght Longitud	Diametro Diameter Diámetro	Connessioni Connections Conexiones	
					[kg]	[mm]	[mm]	[mm]	[in]
N° 11 Raccordo a "T" femmina/femmina/maschio Female/female/male "T" fitting Racor "T" hembra/hembra/macho		Acciaio zincato Galvanized steel Acero galvanizado		10013449	6,5	-	-	100	4"
				10013450	8			120	5"
				10013452	10			150	6"
				10013453	26			200	8"
				10013454	32			250	10"
N° 12 Raccordo inversione maschio/maschio Male/male inverter coupling Racor inversión macho/macho		Acciaio zincato Galvanized steel Acero galvanizado		10013422	1	-	-	50	2"
				10013424	2,2			100	4"
				10018441	3,4			120	5"
				10013425	4,5			150	6"
N° 13 Raccordo inversione femmina/femmina Female/female inverter coupling Racor inversión hembra/hembra		Acciaio zincato Galvanized steel Acero galvanizado		10013426	1,3	-	-	50	2"
				10013428	3,3			100	4"
				10013429	4			120	5"
				10013430	5			150	6"
N° 14 Riduzione maschio/femmina Male/female reducer Reducción macho/hembra		Acciaio zincato Galvanized steel Acero galvanizado		10013434	3,5	-	80	100	4"
				10013435	4,8		100	120	5"
				10013436	5,5		100	150	6"
				10013437	5,5		120	150	6"
				10018442	8		150	200	8"
				10018444	13		150	250	10"
				10013431	3,6		100	80	3"
				10013432	4,9		120	100	4"
				10013439	5,5		150	100	4"
				10013433	5,5		150	120	5"
N° 15 Saracinesca maschio/femmina Male/female gate valve Válvula de compuerta macho/hembra		Acciaio zincato Galvanized steel Acero galvanizado		10013684	5,5	-	-	80	3"
				10016741	9			100	4"
				10013685	10			120	5"
				10018447	14			150	6"
N° 16 Guarnizione O- ring Junta tórica		Gomma NBR NBR rubber Caucho NBR		10013049	0,02	-	-	50	2"
				10013051	0,05			80	3"
				10013052	0,07			100	4"
				10013053	0,1			120	5"
				10013054	0,15			150	6"
				10013056	0,28			200	8"
				10013057	0,47			250	10"
				10013058	0,67			300	12"
N° 17 Presa completa Cock assembly Grifo completo		Ottone Brass Latón		10013660	1,5	-	-	32	1 1/4"

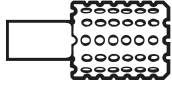
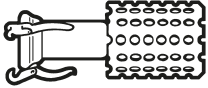

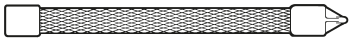

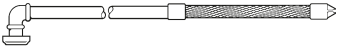
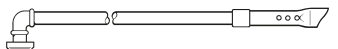
Descrizione Description Descripción		Materiale Material Material	Note Notes Notas	Codice Code Código	Peso Weight Peso [kg]	Lunghezza Length Longitud [m]	Connessioni Connections Conexiones	
							[mm]	[in]
N° 18 Manicotto curvo / Elbow coupling Manguito curvo		Acciaio zincato Galvanized steel Acero galvanizado		10013663	0,6	-	32	1 1/4"
N° 19 Tubo di sollevamento Riser pipe Tubo de elevación		Acciaio zincato Galvanized steel Acero galvanizado		10013687	2,5	1	32	1 1/4"
				10013688	5	2		
				10013689	7,5	3		
				10013690	10	4		
				10013691	12,5	5		
				10013692	15	6		
N° 20 Manicotto / Coupling sleeve Manguito		Acciaio Steel Acero		10013255	0,25	-	32	1 1/4"
N° 22 Manicotto Trasflex femmina/femmina Female/female Trasflex hose coupling Manguito Trasflex hembra/hembra		PVC	Vuoto max Max vacuum 10 m H ₂ O Vacío max	10013666	2,9	1	40	1 1/2"
N° 23 Tubo di scarico Discharge pipe Tubo de descarga		Acciaio zincato Galvanized steel Acero galvanizado		10019262	9	4,0	80	3"
				10013470	11	5,8		
				10048925	12	6,2		
				10013473	12	4,0	100	4"
				10013474	16	5,8		
				10048926	17	6,2		
				10018448	15,5	4,0	120	5"
				10013477	21	5,8		
				10048927	22,5	6,2		
				10013480	16	3,0	150	6"
				10013478	21,5	4,0		
				10013479	29,5	5,8		
				10048928	32	6,3	200	8"
				10013481	44	4,0		
				10013482	59	5,8		
				10048929	63	6,3	250	10"
				10016773	66	4,0		
				10013483	90	5,8		
				10048930	98	6,4	300	12"
				10013485	80	4,0		
10013486	10	5,8						
10048931	109	6,5						

Descrizione Description Descripción		Materiale Material Material	Note Notes Notas	Codice Code Código	Peso Weight Peso	Lunghezza Length Longitud	Conessioni Connections Conexiones		
					[kg]	[m]	[mm]	[in]	
N° 24 Collettore con attacchi Header pipe with threaded holes Colector con conexiones		Acciaio zincato Galvanized steel Acero galvanizado	N° 3 - 1 1/4"	10018689	12	5,8	100	4"	
				10048936	13	6,2	120	5"	
				10013216	16,5	4,0	150	6"	
				10013219	22,5	4,0	120	5"	
				10013217	22,5	5,8	150	6"	
				10013220	32	5,8	120	5"	
				10048934	24	6,2	150	6"	
				10048935	33	6,3	120	5"	
				10018691	16,5	5,8	150	6"	
				10048941	17,5	6,2			
N° 25 Collettore con prese complete Header pipe complete with cock assemblies Colector con grifos completos		Acciaio zincato Galvanized steel Acero galvanizado	N° 3 - 1 1/4"	10018691	16,5	5,8	100	4"	
				10048941	17,5	6,2			
				10013654	21	4,0			
				10018449	28,5	5,8	120	5"	
				10048940	30	6,2			
				10013655	31,5	5,8			
				10048937	33	6,2			
				10013657	27	4,0			
				10016162	38	5,8	150	6"	
				10048939	39	6,3			
N° 26 Tubo flessibile (PVC con spirale in acciaio) Flexible hose (PVC with steel spiral) Tubo flexible (PVC con espiral de acero)		PVC	Vuoto max Max vacuum [m H ₂ O] Vacío max	10	10013539	9,5	4	50	2"
				10	10013540	12,5	6		
				10	10013541	18	10		
				9	10013549	9	2		
				9	10013550	17	4	80	3"
				9	10013551	19,5	5		
				9	10013552	23	6		
				9	10013561	53	2		
				9	10013563	22	4	100	4"
				9	10013564	26	5		
N° 28 Tubo flessibile (Gomma / tela con spirale in acciaio) Flexible hose (Rubber / canvas with steel spiral) Tubo flexible (Caucho / tela con espiral de acero)		Gomma / tela Rubber / canvas Caucho / tela	Vuoto max Max vacuum [m H ₂ O] Vacío max	6	10013570	16,5	2	120	5"
				6	10013572	20	3		
				6	10013571	27	4		
				6	10018452	38,5	6		
				6	10013573	22,5	2		
				6	10013580	29,5	3	150	6"
				6	10013575	39	4		
				6	10013576	47,5	5		
				6	10013577	55	6		
				8	10013581	42	2		
8	10013582	67	4	200	8"				
8	10018460	79	5						
8	10013583	92	6						
8	10013585	64	2						
8	10016001	77	3	250	10"				
8	10013586	103	4						
8	10013587	124	5						
8	10013588	153	6						
8	10013591	75	2						
8	10018811	112,5	3	300	12"				
8	10013592	150	4						

Descrizione Description Descripción		Materiale Material Material	Note Notes Notas	Codice Code Código	Peso Weight Peso	Lunghezza Lenght Longitud	Pressione Pressure Presión	Conessioni Connections Conexiones			
					[kg]	[m]	[bar]	[mm]	[in]		
N° 29 Manichetta di mandata Flat discharge hose Manguera de descarga		Gomma Rubber Caucho		10012918	0,32/m	-	8	40	1 1/2"		
				10012919	0,41/m		10	50	2"		
				10012920	0,56/m		8	60	2 1/2"		
				10012921	0,77/m		8	80	3"		
				10012915	0,76/m		4	100	4"		
				10012922	1,05/m		8				
				10012923	1,28/m		6	127	5"		
				10012924	1,60/m		4	150	6"		
				10012925	2,40/m		2,5	204	8"		
				10012926	1,30/m		5	250	10"		
				10012927	2,10/m		5	300	12"		
N° 30 Manichetta di mandata con raccordo femmina Flat discharge hose with female coupling Manguera de descarga con racor hembra		Gomma Rubber Caucho		10013597	4,3	10	10	40	1 1/2"		
				10018651	7,5	10	10	50	2"		
				10013606	9	10	8	80	3"		
				10013611	11	10	4	100	4"		
				10018652	14	10	6	127	5"		
				10015378	23,5	10	4	150	6"		
				10015399	28	10	2,5	204	8"		
				10018653	39,5	10	5	250	10"		
				10018654	76	10	5	300	12"		
N° 31 Manichetta di mandata con raccordi maschio/femmina Flat discharge hose with male/female couplings Manguera de descarga con racores macho/hembra		Gomma Rubber Caucho	2 leve / levers / palancas 3 leve / levers / palancas	10013620	5,5	10	8	40	1 1/2"		
				10013621	8	10	10	50	2"		
				10013623	8	10	10	100	4"		
				10013631	11,5	10	8				
				10013638	14,5	10	8	127	5"		
				10013637	15	10	8				
				10018317	18	10	6				
				10013648	23	10	4			150	6"
				10013653	41	10	2,5			204	8"
				10013590	64	10	5			250	10"
10013593	168	10	5	300	12"						
N° 31.1 Manichetta di infissione con raccordi maschio/femmina Jetting hose with male/female couplings Manguera hincado con racores macho/hembra		Gomma / tela Rubber / canvas Caucho / tela		10018699	11	10	10			50	2"

Descrizione Description Descripción		Materiale Material Material	Note Notes Notas	Codice Code Código	Peso Weight Peso	Lunghezza Length Longitud	Connessioni Connections Conexiones	
							[kg]	[m]
N° 32 Filtro di fondo Strainer Filtro de fondo		Acciaio zincato Galvanized steel Acero galvanizado		10013242	0,67	0,200	40	1 1/2"
				10013243	0,95	0,240	50	2"
				10013246	1,95	0,320	80	3"
				10013247	2,87	0,440	100	4"
				10013248	4,5	0,550	120	5"
				10013249	8	0,640	150	6"
				10013252	15,5	0,810	200	8"
N° 33 Filtro di fondo con raccordo femmina Strainer with female coupling Filtro de fondo con racor hembra		Acciaio zincato Galvanized steel Acero galvanizado		10013227	1,7	0,210	50	2"
				10013228	2,8	0,320	80	3"
				10013229	5	0,450	100	4"
				10013230	7,5	0,610	120	5"
				10013231	10,5	0,700	150	6"
				10013234	22	0,910	200	8"
				10013235	90	1,190	250	10"
N° 34 Tubo di aspirazione flessibile con filtro (PVC con spirale in acciaio) Flexible suction hose with strainer (PVC with steel spiral) Tubo de aspiración flexible con filtro (PVC con espiral de acero)		PVC + Acciaio zincato PVC + Galvanized steel PVC + Acero galvanizado		10013495	9,5	4	50	2"
				10013496	11	6		
				10013497	12,5	6	60	2 1/2"
				10013503	15	6		
				10013506	17,5	4	80	3"
				10013507	20,5	5		
				10013508	24	6	100	4"
				10013520	22,5	4		
				10013521	26,5	5	120	5"
				10013522	31	6		
N° 35 Tubo di aspirazione flessibile con filtro (Gomma / tela con spirale in acciaio) Flexible suction hose with strainer (Rubber / canvas with steel spiral) Tubo de aspiración flexible con filtro (Caucho / tela con espiral de acero)		Gomma / tela + Acciaio zincato Rubber / canvas + Galvanized steel Caucho / tela + Acero galvanizado		10017849	30	4	150	6"
				10015729	38	6		
				10013530	28	2	200	8"
				10029782	30	3		
				10013529	44	4	100	4"
				10013527	52	5		
				10013528	60	6	120	5"
				10013534	73,5	4		
				10013535	99,5	6		
				N° 37 Punta filtrante (telaio in alluminio, guaina filtrante inox reps) Wellpoint spear (aluminium frame, reps stainless steel screen) Punta de filtración (bastidor de aluminio, vaina de filtración inoxidable reps)		Alluminio + Acciaio inox Aluminium + Stainless steel Aluminio + Acero inoxidable		10013671

Descrizione Description Descripción		Materiale Material Material	Note Notes Notas	Codice Code Código	Peso Weight Peso	Lunghezza Length Longitud	Connessioni Connections Conexiones	
							[kg]	[m]
N° 39 Punta filtrante per ghiaia Wellpoint spear for gravel Punta de filtración para gravilla		Alluminio Aluminium Aluminio		10013682	1,7	0,350	32	1 1/4"
N° 44 Tubo di sollevamento + punta filtrante (Rif. 37) Riser pipe + wellpoint spear (Ref. 37) Tubo de elevación + punta de filtración (Ref. 37)		Alluminio + Acciaio Aluminium + Steel Aluminio + Acero		10013680	10	3	32	1 1/4"
				10013681	12,5	4		
				10018701	15	5		
				10017024	17,5	6		
N° 45 Tubo di sollevamento + punta filtrante per ghiaia Riser pipe + wellpoint spear for gravel Tubo de elevación + punta de filtración para gravilla		Alluminio + Acciaio Aluminium + Steel Aluminio + Acero		10016932	10	3	32	1 1/4"
				10016798	12,5	4		
				10013683	15	5		
				10018669	17,5	6		
N° 46 Tubo di sollevamento Riser pipe Tubo de elevación		NEW PVC		10045490	3	2	32	1 1/4"
				10045491	4,5	3		
				10045492	5,5	4		
				10045493	7	5		
				10045494	8	6		
N° 47 Tubo di sollevamento con gomito Riser pipe with elbow Tubo de elevación con codo		NEW PVC		10045226	3	2	32	1 1/4"
				10045225	4	3		
				10044480	5	4		
				10044479	6,5	5		
				10044481	9	6		
N° 48 Punta filtrante Wellpoint spear Punta de filtración		NEW PVC + PE HD		10044478	0,7	-	32	1 1/4"
N° 49 Tubo di sollevamento con gomito e punta filtrante Riser pipe with elbow and wellpoint spear Tubo de elevación con codo y punta de filtración		NEW PVC + PE HD		10045224	3,4	2	32	1 1/4"
				10045223	4,6	3		
				10044483	6	4		
				10044482	7	5		
				10044484	8,5	6		

Descrizione Description Descripción		Materiale Material Material	Note Notes Notas	Codice Code Código	Peso Weight Peso	Lunghezza Length Longitud	Conessioni Connections Conexiones					
							[kg]	[m]	[mm]	[in]		
N° 50 Tubo di scarico con raccordi Discharge pipe with couplings Tubo de descarga con racores		NEW PE HD	PN 6 bar	10045076	10	3,0	100	4"				
				10045075	12	4,0						
				10045074	16	5,8						
								10045236	12,5	4,0	120	5"
								10045237	15,5	5,8		
								10045238	18,5	4,0	150	6"
								10045239	26	5,8		
N° 51 Collettore con 3 attacchi Header pipe with 3 threaded holes Colector con 3 conexiones		NEW PE HD	N° 3 - 1 1/4" PN 6 bar	10044487	6,5	5,8	100	4"				
				10045241	10,5	4,0	120	5"				
				10045242	17	4,0	150	6"				
N° 52 Collettore con 6 attacchi Header pipe with 6 threaded holes Colector con 6 conexiones		NEW PE HD	N° 6 - 1 1/4" PN 6 bar	10044486	17,5	5,8	120	5"				
				10044485	27,5	5,8	150	6"				
N° 53 Collettore con 3 prese complete Header pipe with 3 cock assemblies Colector con 3 grifos completos		NEW PE HD	N° 3 - 1 1/4" PN 6 bar	10044488	10	5,8	100	4"				
				10045245	15	4,0	120	5"				
				10045246	21	4,0	150	6"				
N° 54 Collettore con 6 prese complete Header pipe with 6 cock assemblies Colector con 6 grifos completos		NEW PE HD	N° 6 - 1 1/4" PN 6 bar	10044489	25	5,8	120	5"				
				10044490	33	5,8	150	6"				

ACCESSORI STANDARD PER POMPE / STANDARD PUMP ACCESSORIES / ACCESORIOS ESTÁNDARES PARA BOMBAS

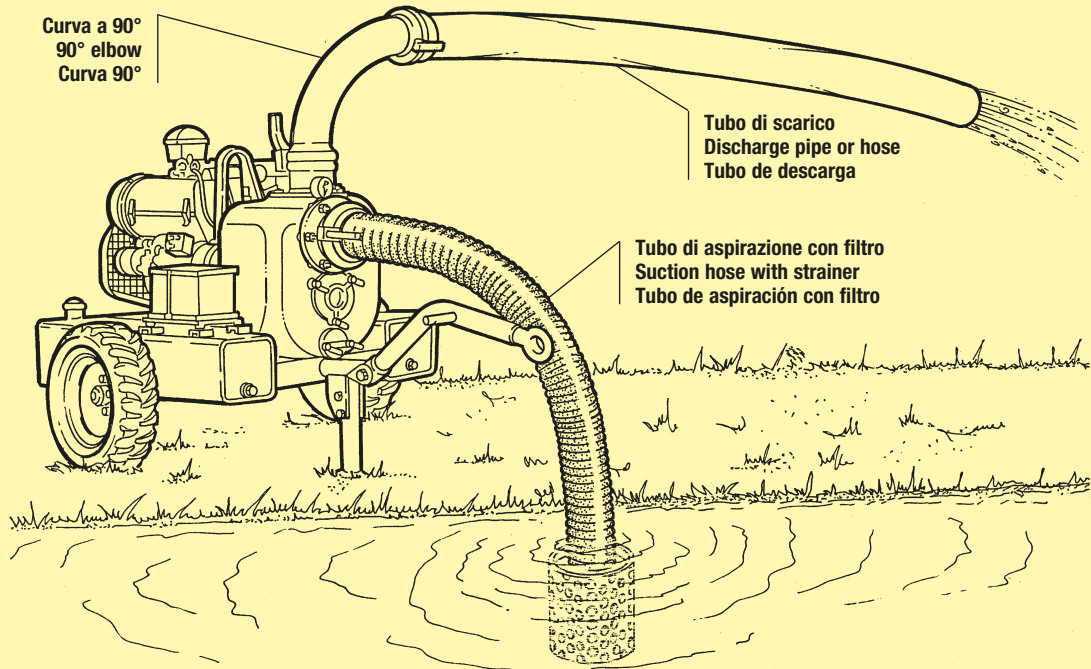

IMPIANTO WELLPOINT STANDARD / STANDARD WELLPOINT SYSTEM / INSTALACIÓN WELLPOINT ESTÁNDAR

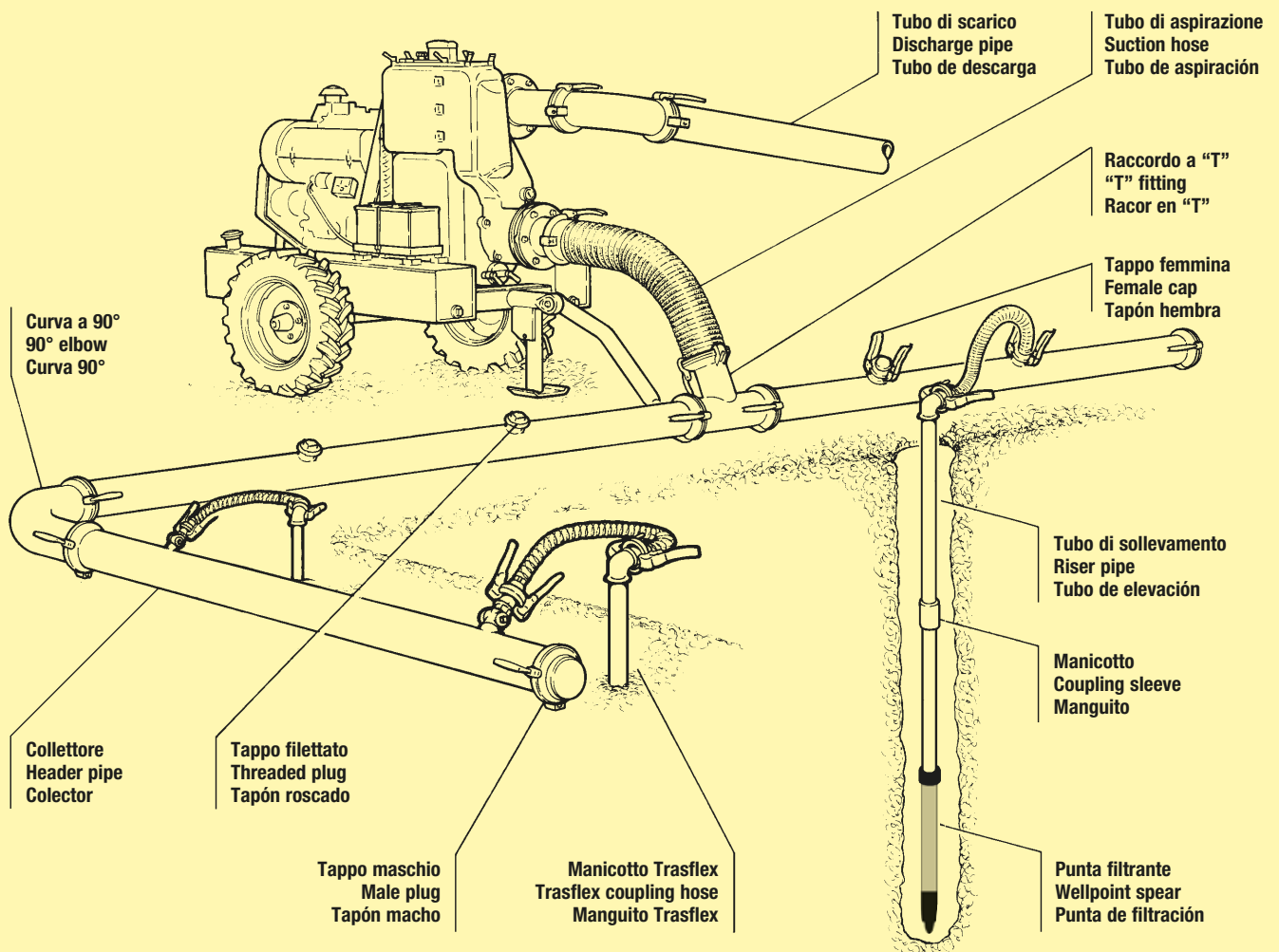

VARISCO S.p.A.
www.variscopspa.com

Terza Strada, 9 - Z.I. Nord
35129 PADOVA - Italy
Tel. +39 049 82 94 111
Fax +39 049 82 94 373

Vendite Italia
Tel. 049 82 94 111
Fax 049 82 94 373
italia@variscopspa.com

International sales
Tel. +39 049 82 94 111
Fax +39 049 80 76 762
export@variscopspa.com

