

Operation and Maintenance Instructions Manual

JU/JW MODEL ENGINES FOR FIRE PUMP APPLICATIONS

This manual covers John Deere Engines
prepared by Clarke
for fire pump service

**Clarke UK, Ltd.
Unit 1, Grange Works
Lomond Road
Coatbridge
ML5 2NN
United Kingdom
TELE: +44(0)1236 429946
FAX: +44(0)1236 427274**

**Clarke Fire Protection Products, Inc.
3133 E. Kemper Road
Cincinnati, OH 45241
U.S.A.**

**TELE: +1.513.771.2200 Ext. 427
FAX: +1.513.771.5375**

www.clarkefire.com

CONTENTS

SUBJECT	PAGE
1.0 INTRODUCTION	6
1.1 IDENTIFICATION/NAMEPLATE	6
1.2 SAFETY/CAUTION/WARNINGS	7
2.0 INSTALLATION/OPERATION	12
2.1 TYPICAL INSTALLATION	12
2.2 ENGINE STORAGE	13
2.2.1 Storage Less than 1 year	13
2.2.2 Extended Storage Maintenance Procedure	13
2.3 INSTALLATION INSTRUCTIONS	14
2.4 SPECIFIC FLYWHEEL COUPLING ALIGNMENT INSTRUCTIONS	15
2.4.1 Listed Driveshaft	15
2.4.2 Driveshaft	15
2.4.3 Other Coupling Types	18
2.5 WEEKLY TEST	18
2.6 STARTING/STOPPING THE ENGINE	18
2.6.1 Special Notes to Equipment Installer of an LPCB Approved (LPS1239) Engine Model	18
2.6.2 To Start Engine	19
2.6.3 To Stop Engine	21
2.6.4 Emergency Operation – ETR Engines Only	21
3.0 ENGINE SYSTEMS	21
3.1 FUEL SYSTEM	21
3.1.1 Bleeding the Fuel System	21
3.1.1.1 JU4/6 UF, NL	21
3.1.1.2 JU4/6 LP	22
3.1.1.3 JW6 UF, NL	22
3.1.2 Draining the Condensate from the Fuel Filter	24
3.1.3 Changing Fuel Filter Cartridge	24
3.1.3.1 JU4/6 UF, NL	24
3.1.3.2 JU4/6 LP	25
3.1.3.3 JW6 UF, NL	25
3.1.4 Fuel Tanks	26
3.1.5 JU Fuel Injection Pump Components	26
3.1.6 JW Fuel Injection Pump Components	27
3.2 AIR/EXHAUST SYSTEM	27
3.2.1 Ambient Conditions	27
3.2.2 Ventilation	27
3.2.3 Standard Air Cleaner	27

3.2.4 Crankcase Ventilation.....	28
3.2.4.1 Open Crankcase Ventilation.....	28
3.2.4.2 Crankcase Ventilation System.....	29
3.2.5 Exhaust System.....	29
3.3 LUBRICATION SYSTEM.....	30
3.3.1 Checking Sump Oil.....	30
3.3.2 Changing Engine Oil.....	30
3.3.3 Changing Oil Filter Cartridge.....	30
3.3.4 Oil Specification.....	31
3.3.5 Oil Capacities.....	31
3.4 COOLING SYSTEM.....	31
3.4.1 Intended Engine Operating Temperature.....	31
3.4.2 Engine Coolant.....	31
3.4.3 Water.....	31
3.4.4 Coolant Capacities.....	32
3.4.5 Coolant Inhibitor.....	32
3.4.6 Procedure for Filling Engine.....	33
3.4.6.1 Engines without Coolant Recovery Tank.....	33
3.4.6.2 Engines with Coolant Recovery Tank.....	34
3.4.7 Providing Raw Water Supply to the Engine Heat Exchanger.....	34
3.4.7.1 Raw Water Supply.....	34
3.4.7.2 Cooling Loop.....	34
3.4.7.3 Setting Raw Water Flow Rate.....	35
3.4.7.4 Raw Water Outlet.....	36
3.4.7.5 Raw Water Quality Strainers, Deterioration of Heat Exchanger (CAC).....	36
3.4.7.6 Backflow Preventers.....	36
3.4.7.7 Raw Water Outlet Temperature.....	36
3.4.8 Flow Paths of Engine Cooling System.....	36
3.4.9 Important Service Notice.....	37
3.4.9.1 Water Pump Cavitation.....	38
3.5 ELECTRICAL SYSTEM.....	38
3.5.1 Wiring Diagrams.....	38
3.5.2 Checking Drive Belt Tension and Adjustment.....	39
3.5.3 Speed Switch.....	39
3.5.4 Magnetic Pick-Up.....	39
3.5.5 Mechanical Engine Control & Alarm Board (MECAB) Speed Switch Troubleshooting.....	39
3.5.6 Field Simulation of Pump Controller Alarms.....	41
3.5.7 Battery Requirements.....	42
3.6 ENGINE SPEED ADJUSTMENT.....	42
4.0 MAINTENANCE SCHEDULE.....	42

4.1 ROUTINE MAINTENANCE.....	42
5.0 TROUBLE SHOOTING.....	43
6.0 PARTS INFORMATION.....	43
6.1 SPARES.....	43
6.2 ENGINE MAINTENANCE PARTS LIST.....	43
7.0 OWNER ASSISTANCE.....	43
8.0 WARRANTY.....	43
8.1 GENERAL WARRANTY STATEMENT.....	43
8.2 CLARKE WARRANTY.....	44
8.3 JOHN DEERE WARRANTY.....	44
9.0 ATCM CALIFORNIA EMISSION REGULATIONS FOR STATIONARY ENGINES.....	47
10.0 INSTALLATION & OPERATION DATA (See Page 5).....	48
11.0 WIRING DIAGRAMS (See Page 5).....	48
12.0 PARTS ILLUSTRATION (See Page 5).....	48
13.0 APPENIX (Alpha Index)	49
APPENDIX “A”.....	50

Check factory availability for a manual in one of the following languages:

Spanish	MP-7 C13961
French	MP-7 C13962
German	MP-7 C13963
Italian	MP-7 C13964

NOTE

The information contained in this book is intended to assist operating personnel by providing information on the characteristics of the purchased equipment.

It does not relieve the user of their responsibility of using accepted practices in the installation, operation, and maintenance of the equipment.

NOTE: CLARKE FPPG Reserves the right to update the contents of this publication without notice.

Technical Catalog Discontinuation Notice

Effective January 2015,

Clarke has done away with the Technical Catalogs. The Technical Catalogs consisted of the following technical documents:

- Model Specific Installation and Operations Data (I&O)
- NFPA20 Cooling Loop C13977
- NFPA20 Lead Acid Battery Specifications C131885
- NFPA20 Exhaust Piping C06918
- NFPA20 Fuel Line Plumbing C132026
- DC Jacket Water Heater Wiring Diagrams
- AC Wiring Diagrams
- Parts Illustration
- Language Translation Pages

All the above can be located on www.clarkefire.com as follows:

- ❖ For all documents listed above, use the following steps to get to the document pages that you are looking for:

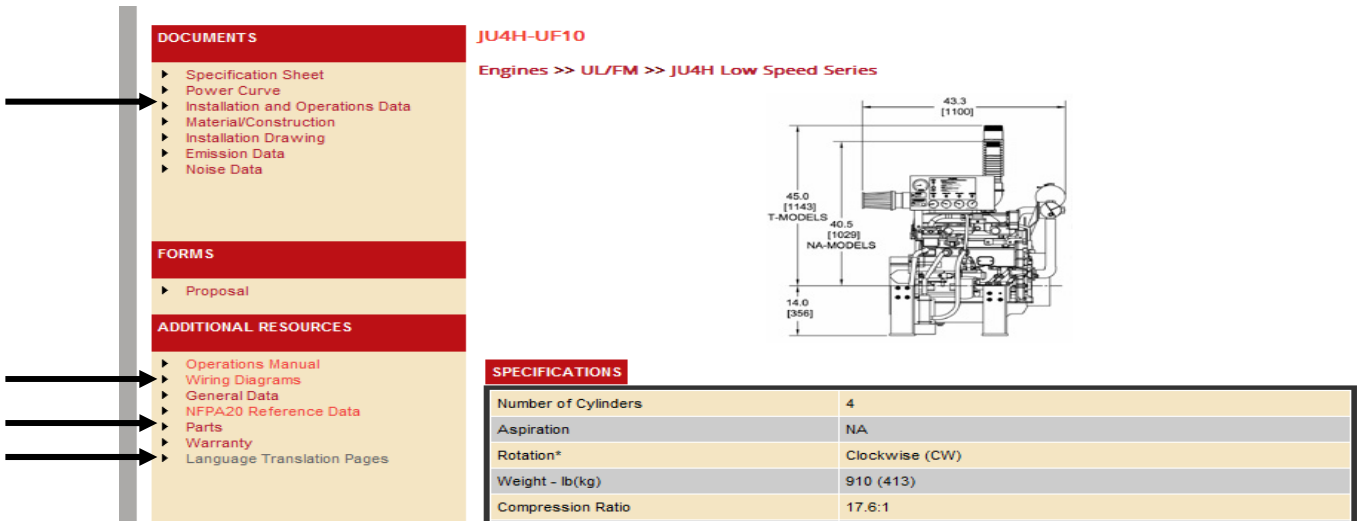
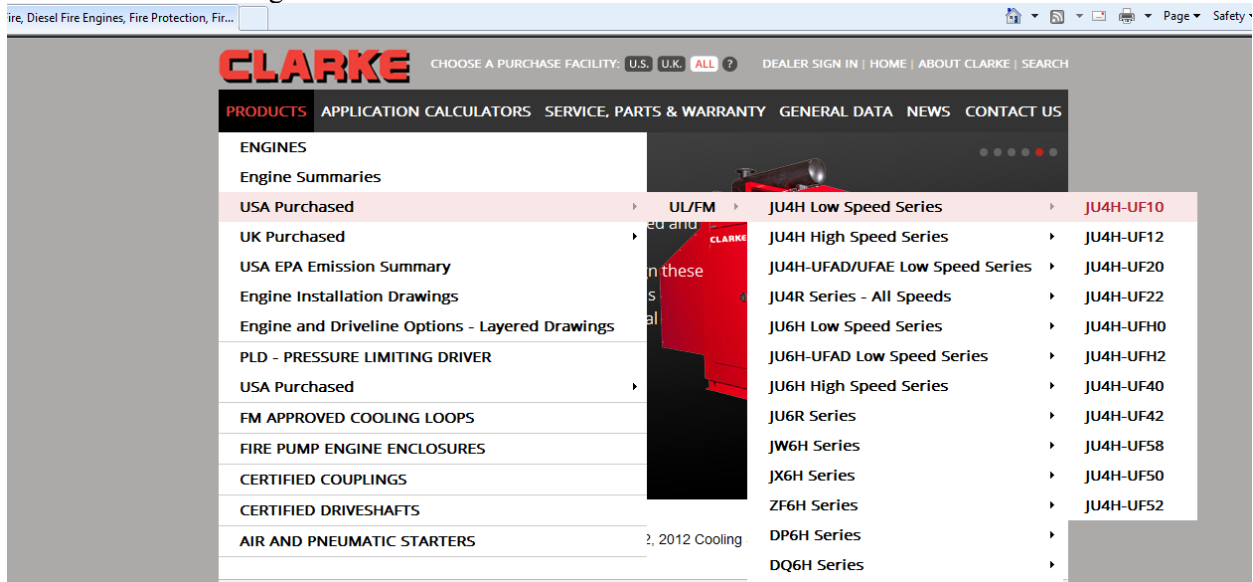

1.0 INTRODUCTION

SCOPE OF SUPPLY

The following paragraphs summarize the “Scope of Supply” of the Engine:

- The CLARKE Engine supplied has been designed for the sole purpose of driving a stationary Emergency Fire Pump. It must not be used for any other purpose.
- Shall not be subjected to Horsepower requirements greater than the certified nameplate rating (for UL/cUL/FM/LPCB only).
- Engines must be sized to cover fully the maximum power absorbed by any particular driven equipment together with a safety factor on no less than 10%. (For Non-listed only).
- Derates for elevation and temperature need to be considered for maximum pump power.
- Fuel delivery settings are factory set with-in the injection pump and must not be tampered with or adjusted. Minor RPM adjustments to meet pump requirements are permissible.
- The engine shall be installed and maintained in accordance with the guidelines stated in this manual.
- Periodic running checks to ensure functionality should be kept to a maximum of ½ hour per week.

1.1 IDENTIFICATION/NAMEPLATE

- Throughout this manual, the terms “Engine” and “Machine” are used.
- The term “Engine” refers solely to the diesel engine driver as supplied by CLARKE.
- The term “Machine” refers to any piece of equipment with which the engine might interface.

This manual provides all the information necessary to operate your newly acquired engine safely and

efficiently, and perform routine servicing correctly. Please read it carefully.

MODEL NUMBERING & IDENTIFICATION

There are two identification plates attached to each engine. Clarke Identification Plate: Engine Model, Serial Number, Rating and Date of Manufacture are shown on this identification plate. The JU Series identification plate is mounted on the stiffening plate that connects the two mounting feet at the rear of the engine. The JW Series identification plate is mounted on right rear engine mount.

Note that there are five types of identification plates, dependent on whether the engine is a “Non-Listed” or “Listed/Approved” Model. These are typical examples. (See *Figure #1*).

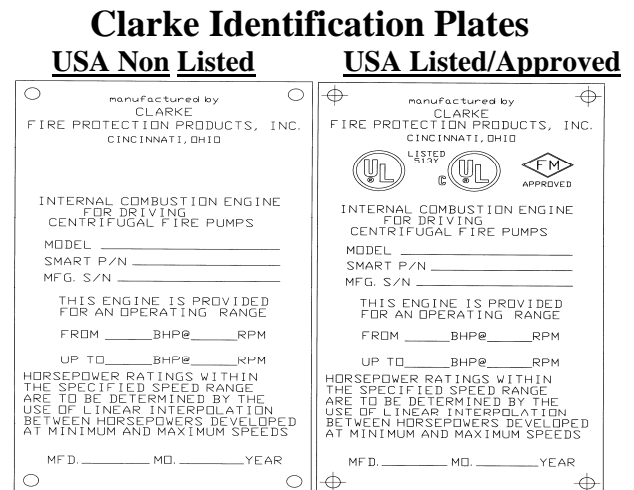

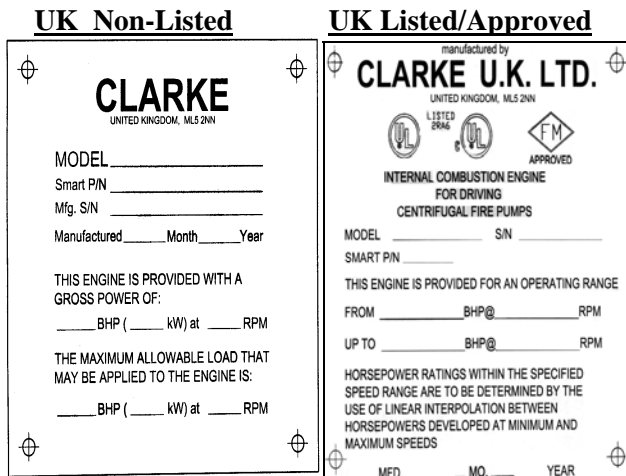

Figure #1

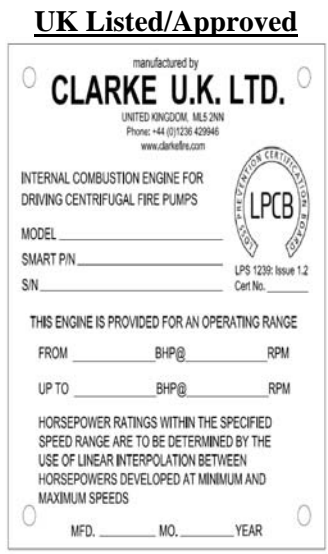

Figure #1 cont'd

The Clarke eight digit model numbers reflects the base engine type, number of cylinders, cooling system, approval listing and a power rating code.

Example: JU6H-UF50

- J = John Deere base engine prepared by CLARKE
- U = base engine series (4.5 liter 4 cylinder or 6.8 liter 6 cylinder)
- 6 = number of cylinders
- H = Heat Exchanger cooled (R = Radiator)
- UF = Underwriters Laboratories Listed/ Factory Mutual Approved, (LP = LPCB Loss Prevention Council Board Approved, NL = Non-Listed, AP = APSAD)
- 50 = A power rating code

The Clarke 10 digit model numbers reflects the base engine type, number of cylinders, cooling system, approval listing, manufacturing location, emissions code and a power rating code.

Example: JU6H-UFAB54

- J = John Deere base engine prepared by CLARKE
- U = base engine series (4.5 liter 4 cylinder or 6.8 liter 6 cylinder)
- 6 = number of cylinders
- H = Heat Exchanger cooled (R = Radiator)
- UF = Underwriters Laboratories Listed/ Factory Mutual Approved, (LP = LPCB Loss Prevention Council Board Approved, NL = Non-Listed)
- A=Manufacturing Location (A= Cincinnati, B= Coatbridge)
- B= EPA NSPS Complaint (A= Non-Emissioned, C=EPA Tier 2 Certified, D=EPA Tier 3 Certified, E=EPA Interim Tier 4 Certified)
- 54 = A power rating code

John Deere Identification Plate: The second identification plate contains the John Deere Model Number and Serial Number. On the JW Series, the John Deere Serial identification plate is located on the left-hand side of the engine between the intake manifold and starting motor. On the JU Series, the John Deere identification plate is located on the right side of the cylinder block behind the fuel filter.

1.2 SAFETY/CAUTION/WARNINGS

ATTENTION: This engine has components and fluids that reach very high operating temperatures and is provided with moving pulleys and belts. Approach with caution. It is the responsibility of the builder of the machine using a Clarke engine to optimize the application in terms of maximum end user safety.

BASIC RULES

The following recommendations are given to reduce the risk to persons and property when an engine is in service or out of service.

Engines must not be used for applications other than those declared under “Scope of Supply”.

Incorrect handling, modifications and use of non-original parts may affect safety. When lifting the engine, take care to use suitable equipment to be applied to the points specially provided as shown on the appropriate Engine Installation Drawing. Engine weights are shown in *figure #2*

ENGINE MODEL	WEIGHT lbs (kg)
JU4H-UF10,12,14,20,22,24, UFAB26, NL14,20,22,24, LP20,24, JU4H-AP50,54	910 (413)
JU4H-UF28,30,32,34,40,42,44,50, 52,54,H8,H0,H2,58, NL30,32, 34,40,42,50,52,54,K4,LP50,54, L4, JU6H-AP30, 34, 50, 54, 60, 84	935 (424)
JU4H-UF84, JU4H-LP84	1085 (492)
JU4H-UFADJ8, UFADJ2, UFADHG JU4H-UFAEA0, UFAEE8, UFAEF2	873 (396)
JU4R-UF09,UF11,13,19,21,23 JU4R-NL09,UF11,13,19,21,23	956 (434)
JU4R-UF40,49,51,53,NL40,49,51,53, UFAEA9, E7, F1	982 (445)
JU6H-UF30,32,34,50,52, 54,D0, D2,G8,M8,M0,M2,58,UFABL0,L2,L8, JU6H-NL30,32,34,50,52,54,M4, LP50,54	1657 (750)
JU6H-UF60,62,68,84,UFAB76, UFAARG,Q8,PG,S0,UFKARG,Q8,PG, S0,NL60,62,74,84,R4,NLKARG,Q8,PG, S0, LP60,84	1693 (766)
JU6R-NLAAD9, JU6R-NLAAD1, JU6R-NLAA29, JU6R-NLAA31, JU6R- NLAA33, JU6R-NLAAG7, JU6R- NLAAL7, JU6R-NLAAL9, JU6R- NLAAL1, JU6R-NLAAM7, JU6R- NLAAM9, JU6R-NLAAM1, JU6R- NLAA57, JU6R-NLAA49, JU6R- NLAA51, JU6R-NLAA53, JU6R-NLKAD9, JU6R-NLKAD1, JU6R-NLKA29, JU6R-NLKA31, JU6R- NLKA33, JU6R-NLKAG7, JU6R- NLKAL7, KU6R-NLKAL9, JU6R- NLKAL1, JU6R-NLKAM7, JU6R- NLKAM9, JU6R-NLKAM1, JU6R- NLKA57, JU6R-NLKA49, JU6R- NLKA51, JU6R-NLKA53, JU6R- UFAAD9, JU6R-UFAAD1, JU6R- UFAA29, JU6R-UFAA31, JU6R- UFAA33, JU6R-UFAAG7, JU6R- UFAAL7, JU6R-UFAAL9, JU6R- UFAAL1, JU6R-UFAAM7, JU6R- UFAAM9, JU6R-UFAAM1, JU6R- UFAA57, JU6R-UFAA49, JU6R- UFAA51, JU6R-UFAA53, JU6R- UFKAD9, JU6R-UFKAD1, JU6R- UFKA29, JU6R-UFKA31, JU6R- UFKA33, JU6R-UFKAG7, JU6R- UFKAL7, JU6R-UFKAL9, JU6R- UFKAL1, JU6R-UFKAM7, JU6R- UFKAM9, JU6R-UFKAM1, JU6R- UFKA57, JU6R-UFKA49, JU6R- UFKA51, JU6R-UFKA53	1744 (791)
JU6R-NLAA67, JU6R-NLAA59, JU6R- NLAA61, JU6R-NLAAPF, JU6R- NLAAQ7, JU6R-NLAARF, JU6R- NLAA59, JU6R-NLAA83, JU6R- NLKA67, JU6R-NLKA59, JU6R-	1744 (791)
JU6R-NLAA67, JU6R-NLAA59, JU6R- NLAA61, JU6R-NLAAPF, JU6R- NLAAQ7, JU6R-NLAARF, JU6R- NLAA59, JU6R-NLAA83, JU6R- NLKA67, JU6R-NLKA59, JU6R-	1844 (836)

NLKA61, JU6R-NLKAPF, JU6R- NLKAQ7, JU6R-NLKARF, JU6R- NLKAS9, JU6R-NLKA83, JU6R- UFAA67, JU6R-UFAA59, JU6R- UFAA61, JU6R-UFAAPF, JU6R- UFAAQ7, JU6R-UFAARF, JU6R- UFAAS9, JU6R-UFAA83, JU6R- UFKA67, JU6R-UFKA59, JU6R- UFKA61, JU6R-UFKAPF, JU6R- UFKAQ7, JU6R-UFKARF, JU6R- UFKAS9, JU6R-UFKA83	
JW6H-UF30 (JDFP-06WA),38,NL30 JW6H-AP30	2012 (910)
JW6H-UF40 (JDFP-06WR),48,NL40, JW6H-AP40	2003 (906)
JW6H-UF50,60,58,H8,NL50, 60, JW6H-AP50, 60	2053 (929)

Figure #2

Figure #3 shows the typical lifting arrangement of a bare engine. Note the lifting points on the engine are for lifting the engine only. *Caution, when lifting, lift point should always be over the equipment Center of Gravity.*

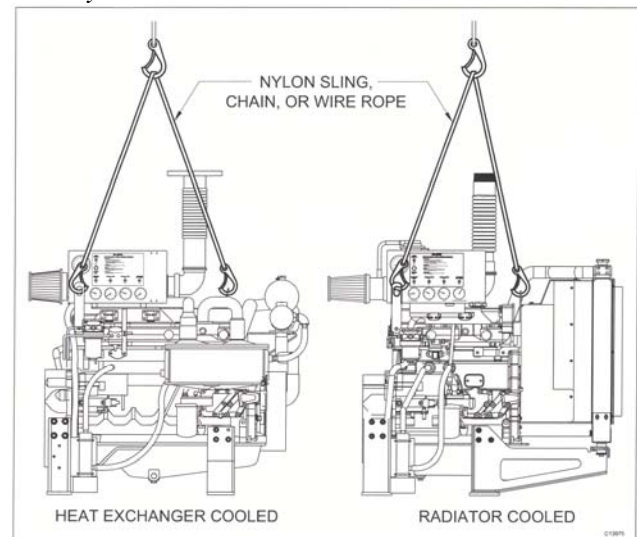
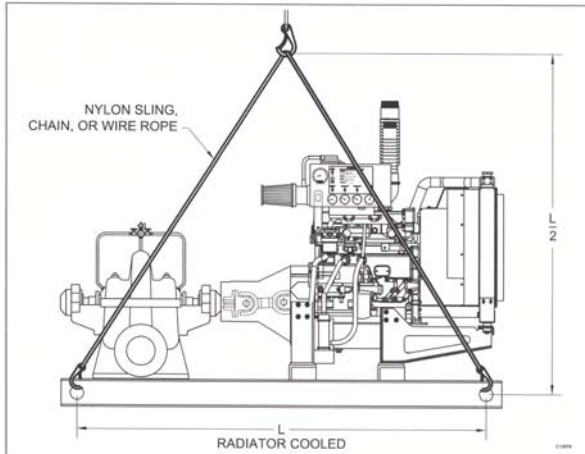
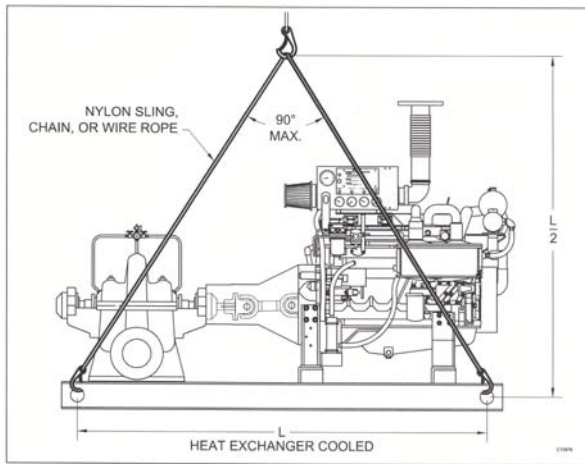

Figure #3

Figure #4 shows the typical lifting arrangement of a base mounted engine and pump set when the base (or module) is furnished with lifting holes.



When Clarke furnishes the base (or module) for the engine and pump set, the combined weight of the engine and base (or module) will be indicated on the unit. *Caution, when lifting, lift point should always be over the equipment Center of Gravity.*

Note: The engine produces a noise level exceeding 70 dB(a). When performing the weekly functional test, it is recommended that hearing protection be worn by operating personnel.

CLARKE UK provides the machine manufacturer with a “Declaration of Incorporation” for the Engine, when required, a copy of which is enclosed in the manual. This document clearly states the machine manufacturers’ duties and responsibilities with respect to health and safety. Refer to *Figure #5*.

CLARKE UK, LTD.

Fire Protection Products

GRANGE WORKS, LOMOND ROAD, COATBRIDGE, UNITED KINGDOM, ML5 2NN

TEL: 0044 1236 429946 FAX: 0044 1236 427274

DECLARATION OF INCORPORATION

We hereby declare that the engine is intended to be incorporated into other machinery and must not be put into service until the relevant machinery, into which the engine is to be incorporated, has been declared in conformity with the essential health and safety requirements of the machinery Directive 2006/42/EC and consequently the conditions required for the CE Mark.

We declare that the engine is manufactured in accordance with the following Standards and Directives:

Directive 2006/42/EC, 2004/108/EC, 2006/95/EC

Standards EN ISO 12100:2010, EN 60204-1:2006

1) Description – Diesel Engines

Manufacturer – Clarke UK

Model Number –

Serial Number –

Year of Manufacture –

Contract Number –

Customer Order Number –

2) The engine has moving parts, areas of high temperatures and high temperature fluids under pressure. In addition it has an electrical system which may be under strong current.

3) The engine produces harmful gases, noise and vibration and it is necessary to take suitable precautionary measures when moving, installing and operating the engine to reduce risk associated with the characteristics stated above.

4) The engine must be installed in accordance with local laws and regulations. The engine must not be started and operated before the machinery into which it is to be incorporated and/or its overall installation has been made to comply with local laws and regulations. The engine must only be used in accordance with the scope of supply and the intended applications.

Signed _____ Date: _____

John Blackwood – Managing Director

REGISTERED IN SCOTLAND NO: 81670 C130896, Rev. J 16JUL12

Figure #5

WHAT TO DO IN AN EMERGENCY

Any user of the Engine who follows the instructions set out in this manual, and complies with the instructions on the labels affixed to the engine are working in safe conditions.

If operating mistakes cause accidents call for help
If operating mistakes cause accidents call for help immediately from the EMERGENCY SERVICES.
In the event of an emergency, and while awaiting the arrival of the EMERGENCY SERVICES, the following general advice is given for the provision of first aid.

FIRE

Put out the fire using extinguishers recommended by the manufacturer of the machine or the installation.

BURNS

- 1) Put out the flames on the clothing of the burns victim by means of:
 - × drenching with water
 - × use of powder extinguisher, making sure not to direct the jets onto the face
 - × blankets or rolling the victim on the ground
- 2) Do not pull off strips of clothing that are sticking to the skin.
- 3) In the case of scalding with liquids, remove the soaked clothing quickly but carefully.
- 4) Cover the burn with a special anti-burn packet or with a sterile bandage.

CARBON MONOXIDE POISONING (CO)

Carbon monoxide contained in engine exhaust gases is odorless and dangerous because it is poisonous and with air, it forms an explosive mixture.

Carbon monoxide is very dangerous in enclosed premises because it can reach a critical concentration in a short time.

When attending a person suffering from CO poisoning in enclosed premises, ventilate the premises immediately to reduce the gas concentration.

When accessing the premises, the person providing the aid must hold his breath, not light flames, turn on

lights or activate electric bells or telephones so as to avoid explosions.

Take the victim to a ventilated area or into the open air, placing him on his side if he is unconscious.

CAUSTIC BURNS

- 1) Caustic burns to the skin are caused by acid escaping from the batteries:
 - × remove the clothes
 - × wash with running water, being careful not to affect injury-free areas
- 2) Caustic burns to the eyes are caused by battery acid, lubricating oil and diesel fuel.
 - × Wash the eye with running water for at least 20 minutes, keeping the eyelids open so that the water runs over the eyeball and moving the eye in all directions.

ELECTROCUTION

Electrocution can be caused by:

- 1) The engine's electrical system (12/24 VDC)
- 2) The electrical coolant pre-heating system 120/240 Volt AC (if supplied) AC current.

In the first case, the low voltage does not involve high current flows through the human body; however, if there is a short circuit, caused by a metal tool, sparks and burns may occur.

In the second case, the high voltage causes strong currents, which can be dangerous.

If this happens, break the current by operating the switch before touching the injured person.

If this is not possible, bear in mind that any other attempt is highly dangerous also for the person assisting; therefore, any attempt to help the victim must be carried out without fail using means that are insulating.

WOUNDS AND FRACTURES

The wide range of possible injuries and the specific nature of the help needed means that the medical services must be called.

If the person is bleeding, compress the wound externally until help arrives.

In the case of fracture do not move the part of the body affected by the fracture. When moving an injured person permission from that person must be received until you can help him. Unless the injury is life threatening, move the injured person with extreme care and then only if strictly necessary.

WARNING LABELS

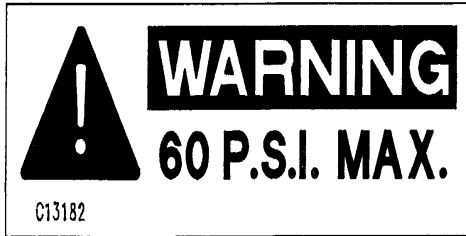

Coolant Mixture



Lifting Point

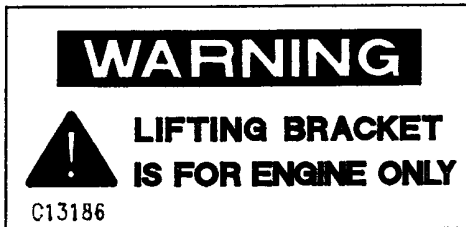

Automatic Start



Rotating Parts



Warning labels, in picture form, are applied to the engine. Their meanings are given below.

Important Note: Labels that show an exclamation mark indicate that there is a possibility of danger.

Heat Exchanger Maximum Working Pressure

Jacket Water Heater Voltage

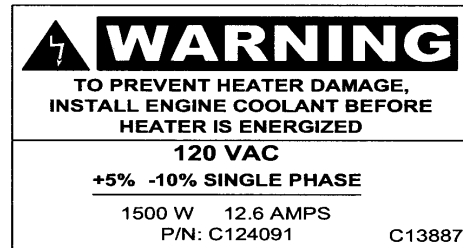

Air Filter Installation



2.0 INSTALLATION/OPERATION

2.1 TYPICAL INSTALLATION

A typical Fire Pump installation is shown in *Figure #6 & 6A*.

1. Pump/Engine set
2. Main Pump Controller
3. Pump discharge
4. Air louver
5. Entrance door with air louver
6. Exhaust silencer
7. Exhaust system supports
8. Exhaust outlet pipe
9. Concrete base
10. Exhaust flexible connection joint/pipe
11. Air Discharge Duct from Radiator

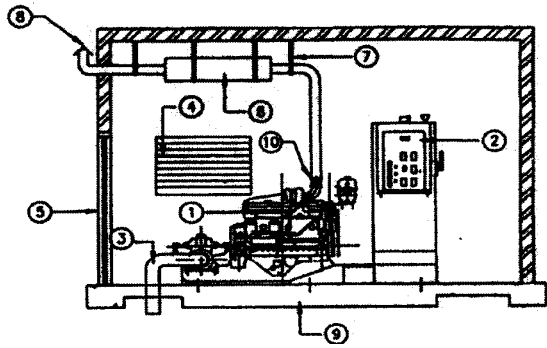

Figure #6
Typical Installation
Heat Exchanger Cooled Engine

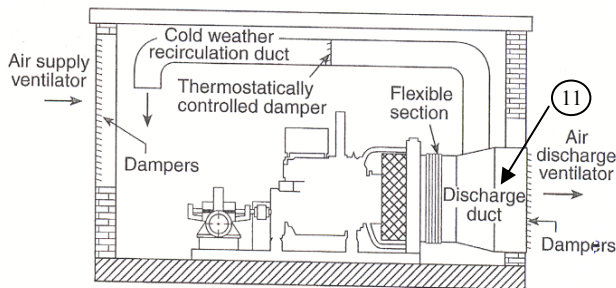

Figure #6A
Typical Installation
Radiator Cooled Engine

For radiator cooled engines, the total air supply path to the pump room, which includes any louvers or dampers, shall not restrict the flow of the air more than 0.2" (5.1mm) water column. Likewise, the air discharge path, which includes any louvers, dampers, or ducting, shall not restrict the flow of air more than 0.3" (7.6mm) water column.

2.2 ENGINE STORAGE

2.2.1 Storage less than 1 year

Storing engines requires special attention. Clarke engines, as prepared for shipment, may be stored for a minimum of one year. During this period, they should be stored indoors in a dry environment. Protective coverings are recommended provided they are arranged to allow for air circulation. The stored engine should be inspected periodically for obvious conditions such as standing water, part theft, excess dirt buildup or any other condition that may be detrimental to the engine or components. Any such conditions found must be corrected immediately.

2.2.2 Extended Storage Maintenance Procedure

After a one year storage period or if the engine is being taken out of service for more than 6 months, additional preservation service must be performed as follows:

- 1) Drain the engine oil and change the oil filter.
- 2) Refill the engine crankcase with MIL-L-21260 preservative oil.
- 3) Change the fuel filter.
- 4) Install the coolant plugs and install coolant in the normal mix percentage of 50% coolant, 50% water, premixed.
- 5) Remove the protection from the intake and exhaust openings.
- 6) Prepare a container as a fuel source using a mixture of Mobilarna or Sta-Bil with **ONLY** Diesel #2 fuel or "Red" diesel fuel (ASTM D-975) or BS2869 Class A2.
- 7) Disconnect the coupling or drive shaft from the pump.
- 8) Start and run the engine at a slow speed for 1-2 minutes being careful not to exceed the normal operating temperature.
- 9) Drain the oil and coolant.
- 10) Replace the protective plugs that were used for shipping and storage.
- 11) Attach to the engine a visible card, specifying "ENGINE WITHOUT OIL" DO NOT OPERATE".

IMPORTANT: THIS TREATMENT MUST BE REPEATED EVERY 6 MONTHS

PUTTING ENGINE INTO SERVICE AFTER ADDITIONAL PRESERVATION SERVICE:

To restore the normal operation running conditions of the engine, carry out the following:

- 1) Fill the engine sump with the normal recommended oil, to the required level.
- 2) Remove the protective plugs used for shipping and storage.
- 3) Refill cooling water to proper level.
- 4) Remove the card "ENGINE WITHOUT OIL, DO NOT OPERATE".
- 5) Follow all steps of the Installation Instructions when the engine will be put into service.

2.3 INSTALLATION INSTRUCTIONS

The correct installation of the engine is very important to achieving optimum performance and extended engine life.

In this respect, the engine has certain installation requirements, which are critical to how it performs. These requirements are generally associated with the cooling, exhaust, induction air, and fuel systems.

This section of the manual should be read in conjunction with the relevant Installation and Operation Data Sheets. If there is any doubt about an installation, contact should be made with Clarke Customer Support giving exact details of the problem.

All installations should be clean, free of any debris and dry. Care should be taken to ensure that there is easy access to the engine for maintenance and repair. The safety of personnel who may be in the area of the engine when it is running is of paramount importance when designing the installation layout.

- 1) Secure pump set to foundation and complete installation in accordance with pump manufacturer's instructions. Perform engine-

Qty	Description	Location	Engine Model
1	1/8" draincock	Water Heater inlet tube	JU4/6H, JU4/6R
1	1/8" draincock	Coolant heater inlet tube	JDFP, JW6
1	Plug RE46686	Oil Cooler	JU4/6H, JU4/6R
1	3/8" pipe plug	Heat exchanger	JDFP, JW6
1	Electrode plug	Bottom of heat exchanger	JU4/6H

- 4) Fill engine cooling system with premixed 50% water / 50% coolant solution. Use only coolants meeting ASTM-D6210 specifications for heavy-duty diesel engines. Never use light-duty or automotive coolants in the engine that are stated as ASTM-D3306 only. Refer to *Figure #34* in section 3.4.3 for cooling system capacity. Refer to section 3.4.5 for filling procedure.
- 5) Engine is shipped with oil **installed**. For make-up oil specification refer to section 3.3 Lubrication System.
- 6) Connect fuel supply and return line to fuel supply tank plumbing. Reference the Fuel System section of the Installation and

to-pump coupling alignment. Lubricate Falk coupling with supplied grease or driveshaft universal joints with NLGI grade #1 or #2 grease at the (3) Zerk fittings. (Refer to section 2.4 for specific alignment instructions).

- 2a) Engine with Heat Exchanger Cooling: Install the heat exchanger discharge pipe. The discharge pipe should be no smaller than the outlet connection on the heat exchanger. Discharge water piping should be installed in accordance with applicable codes. All plumbing connecting to the heat exchanger must be secured to minimize movement by the engine. Cooling loop water pressure to the heat exchanger must not exceed the limit that is stated on the heat exchanger supplied with the engine.
- 2b) Engine with Radiator Cooling: Connect radiator air discharge ducting to radiator duct flange. Discharge ducting should be installed in accordance with applicable codes. A flexible duct section should be provided to isolate engine from building.
- 3) Install all engine cooling system draincocks and plugs.

Operation Data (see Page 5), for piping size, maximum allowable fuel pump suction, and maximum allowable fuel head requirements. Fill supply tank with **ONLY** #2 diesel fuel (ASTM D-975) or BS 2869 Class A2 "Red" diesel fuel, bleed supply system of air and check for leaks. **CAUTION:** All diesel fire pump drivers manufactured by Clarke are designed and tested for use with only No. 2-D diesel fuel conforming to ASTM D-975. Additionally, in European countries an acceptable alternative fuel is "red" diesel fuel conforming to BS2869 Class A2. Both of these fuel specifications

must contain **NO** (0%) bio-fuel. Fuel supply level must meet applicable code requirements. Do not use a copper based or galvanized material for any component of a diesel fuel system. The fuel will chemically react with the zinc resulting in clogged fuel filters and injector systems.

- 7) Remove protective covering on air cleaner element.
- 8) Connect jacket water heater (if supplied) to AC power source. For JU4/6 Series the electrical supply requirements are indicated on the heater body. Connect the supplied heater connection wire directly to a customer supplied electrical junction box. For JDFP/JW6 Series the electrical supply requirements are indicated on the connection box. Connect to the heater directly to the junction box at the end of the heater only. **Supply wiring should never be routed through the engine gauge panel.** Severe damage to critical engine control components could result. Energize heater only after step #4 is completed.
- 9) Connect exhaust system to flexible connection on the engine. The exhaust system plumbing must be supported by the building structure and not the engine. The exhaust flexible connection is provided only for the purpose of thermal expansion and vibration isolation, not for misalignment or directional change.
- 10) Make electrical DC connections between the engine gauge panel terminal strip (if supplied) and the controller per the controller manufacturer's instructions. Refer to the wiring diagram sticker located on the inside cover of the engine gauge panel for proper connection of the water solenoid.
- 11) Fill batteries with electrolyte per battery manufacturer's instructions. Connect cables between engine and batteries only after electrolyte is installed. Refer to the wiring diagram inside the engine gauge panel cover (if supplied), or appropriate wiring diagram (see Page 5), for correct positive and negative connections. Connect negative cables directly to the brass ground bolt, as

indicated with tag C133445. On JU4/6 Series connect each positive cable to the large electrical post of the starter motor as indicated with tag C133443. Note: the JU4/6 Series have a separate starter motor for each battery set. On the JDFP/JW6 Series connect each positive cable to the large outer post of the manual starting contactors as indicated with tag C133443.

- 12) Always follow fire pump controller operating instructions when switching on/off battery chargers and disconnecting/reconnecting batteries from engine.
- 13) Note: Clarke Operation and Maintenance Instructions Manual and Clarke parts illustration pages are located inside the engine gauge panel.
- 14) IMPORTANT! In order to obtain prompt Warranty Service and to comply with Emissions Regulations, this engine **must** be registered to the final installation name and address. To register this engine, go to www.clarkefire.com and select Warranty Registration.

2.4 SPECIFIC FLYWHEEL COUPLING ALIGNMENT INSTRUCTIONS

2.4.1 Listed Driveshafts

Refer to Listed Driveshaft Installation, Operation and Maintenance Manual C132355

2.4.2 Driveshaft

To check the alignment of the pump shaft and engine crankshaft centerlines for proper Parallel Offset and Angular tolerance, the driveshaft must be installed between the flywheel drive disc (no drive disc on JW6 models) and the flanged hub on the pump shaft.

Before removing the driveshaft guard, disconnect the negative battery cable from both batteries.

Before beginning the alignment checks and making any necessary corrections, install the driveshaft and re-torque all driveshaft connection bolts to the values given in the following table:

MODELS	DRIVE SHAFT	BOLT SIZE/ MATERIAL GRADE	TIGHTENING TORQUE ft-lbs (N-m)
JU4H-10,12, 14,20,22,24 AB26, AEA0, JU4R-09, 11,13,19, 21,23, AEA9	CDS10-SC SC41 SC41A	7/16-20 Grade 8 (Hi-Tensile)	50 - 55 (68 – 75)
JU4H- 28,30,32,34, 40,42,44,H8, H0,H2, AEE8, AEF2, ADJ8, ADJ2, JU4R- 40, AEE7, AEF1	CDS20-SC SC55 SC55A	1/2-20 Grade 8 (Hi-Tensile)	75 - 82 (102 – 112)
JU6H- D0,D2,30,32, 34, JU6R- D9,D1,29,31, 33	CDS20-S1 SC55L-A	1/2-20 Grade 8 (Hi-Tensile)	75 - 82 (102 – 112)
JU4H- 50,52,54,58, JU4R- 49,51,53	CDS30-S1	3/8-24 Grade 8 (Hi- Tensile)	30-35 (41-48) (See Note 2)
JU6H- G8,M8,M2, M0,58,50,52, 54,ABL8, ABL0,ABL2, AB76, 68,60,62,84 JU6R- AAG7, AAL7, AAL9, AAL1, AAM7, AAM1,AAM9, AA57, AA49, AA51, AA53, AA67, AA59, AA61, AA83, KAG7, KAL7, KAL9, KAL1, KAM7, KAM1, KAM9, KA57, KA49, KA51, KA53, KA67, KA59, KA61, KA83	CDS30-S1 SC61L-A	3/8-24 Grade 8 (Hi- Tensile)	30-35 (41-48) (See Note 2)
JW6	CDS50-SC SC81A	7/16-20 Grade 8 (Hi-Tensile)	50 - 55 (68 – 75) (See Note 2)

JU6H- AAQ8, KAQ8, AARG, KARG, AAPG, KAPG, AAS0 KAS0, JU6R- AAPF, KAPF, AAQ7, KAQ7, AARF, KARF, AAS9, KAS9,	CDS50-SC SC81A	7/16-20 Grade 8 (Hi-Tensile)	50 - 55 (68 - 75) (See Note 2)
---	-------------------	------------------------------------	--------------------------------------

Note 1 – It is recommended that a medium strength threadlocker (i.e. Loctite – blue #64040) be used in the assembly and torquing of all hardware. This may be purchased as part number 23509536.

Note 2 – 4 of the hi-tensile bolts and/or nuts, that are used to connect the driveshaft to the drive disc (all JU6 models) or flywheel (all JW6 models) and that connect the driveshaft to the pump companion flange, will require a “crow’s foot” wrench attached to a standard torque wrench in order to apply the required tightening torque. A standard socket will not work due to close proximity of the bolts and/or nuts with the driveshaft yoke. The tightening torque values listed for these bolts and/or nuts have been corrected for using a “crow’s foot” adapter which extends the standard torque wrench’s length.

The following steps describe the proper way to check alignment. A small pocket scale or ruler with millimeter markings is recommended to make all measurements.

- A) To check the Horizontal Parallel Offset, the driveshaft must be in the proper orientation.
1. Rotate the shaft so the reference “AB” on the flywheel disc or the circumference of the drive shaft flange (against the flywheel) is in the 12 o’clock position shown on figure# 7.
 2. Measure from the rear face of the flywheel drive disc or the drive shaft flange to point A. (Point A is on the bearing bore as shown in *Figure 7*, on the instrument panel side of the engine). This measurement must be:

Measurement	Driveshaft
58 ± 1mm.	CDS10-SC / SC41 / SC41A
68 ± 1.5mm.	CDS20-SC / SC55 / SC55A
68 ± 1.5mm.	CDS20-S1 / SC55L-A
84 ± 1.5mm.	CDS30-S1 / SC61L-A
109 ± 2mm.	CDS50-SC / SC81A

B) With the driveshaft in the same orientation as the previous step (Step A), check the Horizontal Angular alignment of the shafts.

1. Measure from the front face of the drive shaft flange on the pump end to point B. (Point B is the bearing bore on the exhaust side of the engine). This measurement must be equal to the measurement at point A ± 0.5 mm.

C) To check the Vertical Parallel Offset, the driveshaft must be re-orientated.

1. Rotate the shaft 90° so the reference “CD” on the flywheel drive disc or the circumference of the drive shaft flange (against the flywheel) is in the position shown on *Figure#8*.
2. Measure from the rear face of the flywheel drive disc or the drive shaft flange to point C. (Point C is the same as point A with the driveshaft rotated 90°). The measurement must be:

Measurement	Driveshaft
60 ± 1mm.	CDS10-SC / SC41 / SC41A
70.5 ± 1mm.	CDS20-SC / SC55 / SC55A
70.5 ± 1mm.	CDS20-S1 / SC55L-A
86.5 ± 1mm.	CDS30-S1 / SC61L-A
112.5 ± 1mm.	CDS50-SC / SC81A

D) With the driveshaft in the same orientation as the previous step (Step C), check the Vertical alignment of the shafts.

1. Measure the front face of the drive shaft flange on the pump end to point D. (Point D is the same as point B, with the driveshaft rotated 90). The measurement must be equal to the measurement at point C \pm 1 mm.

Re-install all guards and grease fittings before reconnecting the battery cables.

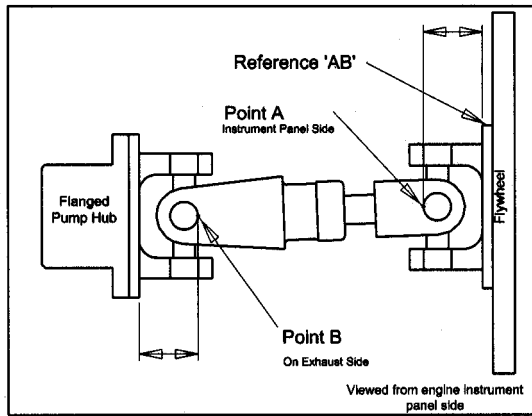

Figure #7

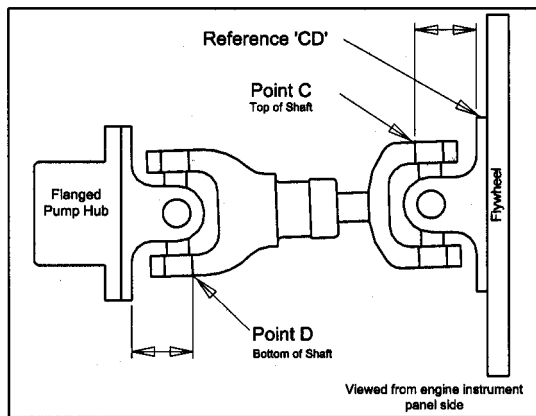

Figure #8

DRIVESHAFT MAINTENANCE

1. To service the driveshaft disconnect the negative battery cables, remove the top of guard and set aside.
2. Rotate engine shaft manually so the u-joint grease fittings are accessible.
3. Using a hand held grease gun with N.L.G.I. grade 1 or 2 grease position on grease fitting. Pump with grease until grease is visible at all four cap seals.
4. Verify all driveshaft connecting bolts remain tight. Re-torque per 2.4.1 if necessary.
5. Reinstall top of guard and connect negative battery cables.

2.4.3 Other Coupling Types

Consult Factory or Clarke website at www.clarkefire.com for additional information.

2.5 WEEKLY TEST

It is recommended that the engine be tested weekly as allowed by local jurisdictions. An experienced operator should be present during the weekly test.

NOTE: This engine is designed to operate at rated load conditions. For testing purposes the engine can be run at lower load (lower flow) conditions. Running times in any one period should not exceed 30 minutes maximum.

Before starting the engine make sure of the following:

- 1) The operator has free access to stop the engine in an emergency.
- 2) The plant room ventilation ducts are open and the engine has good access for air.
- 3) All the guards are in position and, if not, for whatever reason, any rotating parts will be free and clear without restriction.
- 4) Battery covers are in place and there is nothing on top of or touching the engine, which is not part of the original supply specification.
- 5a) Heat Exchanger Cooling: The water supply for coolant is available again without restriction.
- 5b) Radiator Cooling: The air supply for cooling is available again without restriction.

When engine is running make sure that the coolant temperature and oil pressure raw cooling water flow are within the limits specified on the relevant Installation & Operation Data Sheet (see Page 5).

If the coolant temperature is excessive, check:

- a) Cooling loop strainers
- b) Proper functioning of thermostat
- c) Condition of heat exchanger tube bundle

2.6 STARTING/STOPPING THE ENGINE

2.6.1 Special Notes to Equipment Installer of an LPCB Approved (LPS1239) Engine Model:

Any device fitted to the engine or controller, which could prevent the engine starting automatically, shall return automatically to the normal position after manual application. The electrical fuel shutoff actuator shall be connected to an Engine Stop button on the main pump controller.

The main pump controller shall de-energize the start motor when the engine has achieved 700-1000 rpm.

2.6.2 To Start Engine:

Use main pump controller for starting. Follow instructions provided by controller manufacturer.

On UL/FM engines, use main pump controller for starting and stopping the engine. Should the main pump controller become inoperable, the engine can be manually started and stopped from the engine gauge panel. For manual starting and stopping of an engine with a gauge panel: Position **MODE SELECTOR** to **MANUAL RUN**. (Refer to *Figure*

#9). Lift and hold **MANUAL CRANK #1**, until engine starts, or release after 15 seconds. If unit fails to start, wait for 15 seconds, use **MANUAL CRANK #2** and repeat step. If **COOLING WATER** is not flowing or engine **TEMPERATURE** is too **HIGH**, open cooling system manual by-pass valves (applies to heat exchanger cooled engines only).

Note: On JW Engines you can also start engines using manual starting contactors.

On LPCB engines, use main pump controller for starting and stopping the engine. Should the main pump controller become inoperable, the engine can be manually started from the engine gauge panel. For manual starting of an engine with a gauge panel. (Refer to *Figure #9A*): Lift and hold **MANUAL CRANK #1**, until engine starts, or release after 15 seconds. If unit fails to start, wait for 10 seconds, use **MANUAL CRANK #2** and repeat step. If **COOLING WATER** is not flowing or engine **TEMPERATURE** is too **HIGH**, open cooling system manual by-pass valves (applies to heat exchanger cooled engines only).

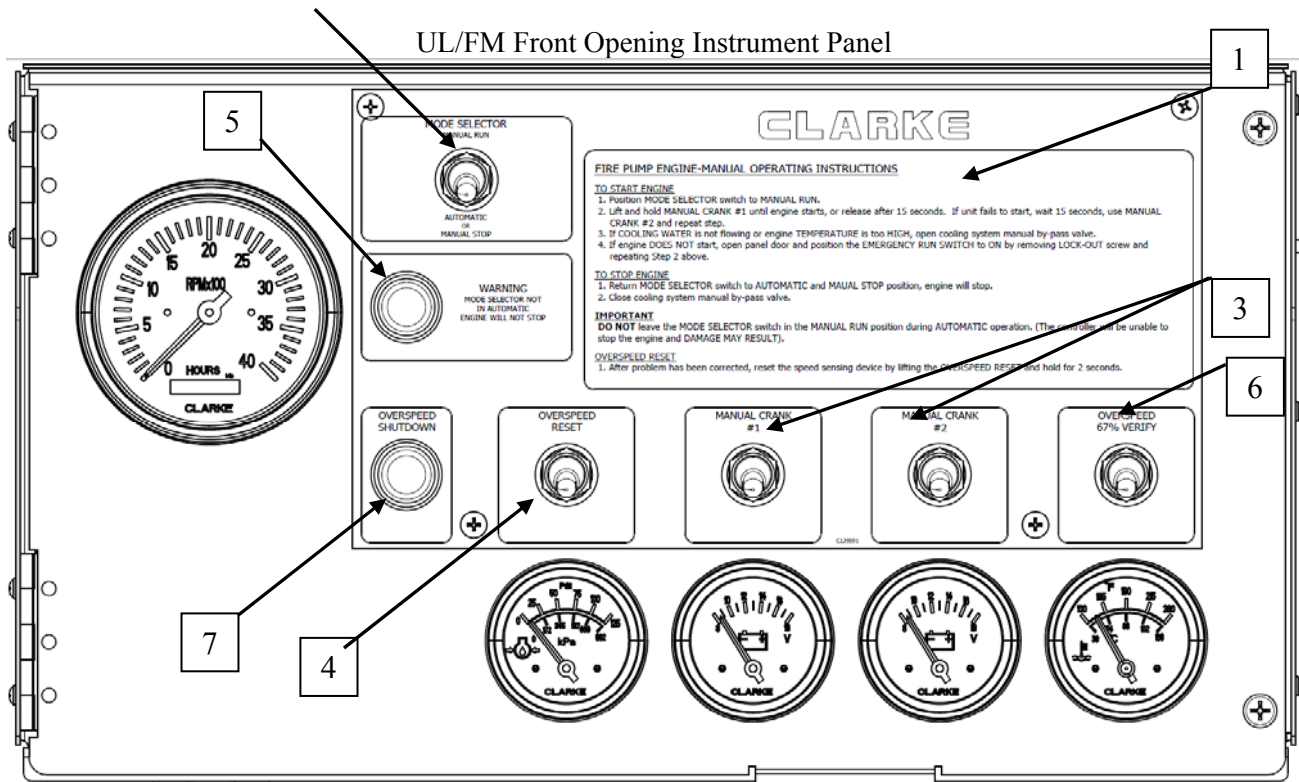
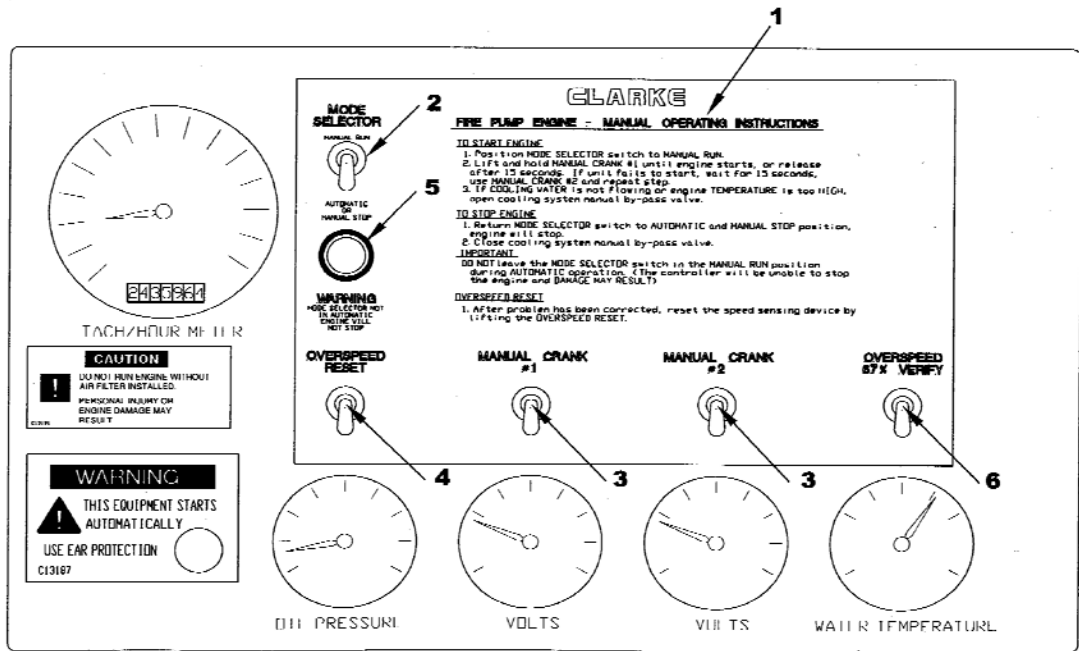

Figure #9

- 1 – Emergency Operating Instructions
- 2 – Automatic-Manual Mode Selector
- 3 – Manual Crank Controls
- 4 – Overspeed Reset
- 5 – Manual Mode Warning Light
- 6 – Overspeed Verification
- 7 – Overspeed Indication Light

Non-Listed Instrument Panel



- | | |
|--------------------------------------|----------------------------|
| 1 – Emergency Operating Instructions | 4 – Overspeed Reset |
| 2 – Automatic-Manual Mode Selector | 5 – Warning Light |
| 3 – Manual Crank Controls | 6 – Overspeed Verification |

LPCB Instrument Panel

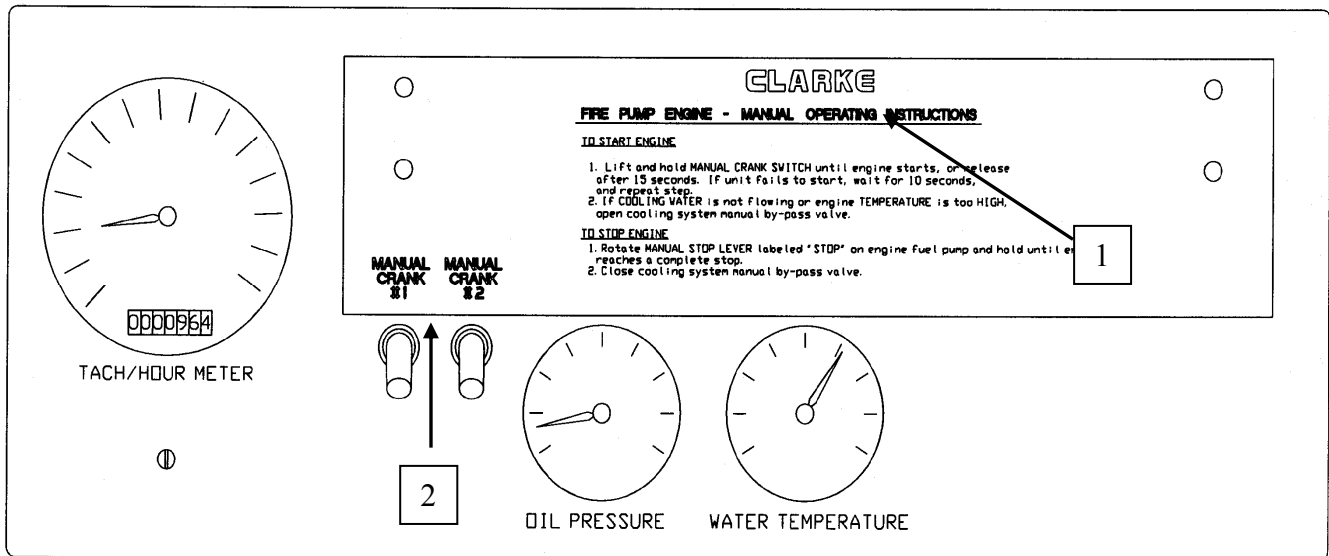

Figure #9A

- | |
|--------------------------------------|
| 1 – Emergency Operating Instructions |
| 2 – Manual Crank Controls |

IMPORTANT: Main pump controller selector should be in the **OFF** position when starting from engine gauge panel. Be sure to return selector on main pump controller and engine gauge panel to **AUTOMATIC** after completing manual run.

2.6.3 To Stop Engine

If engine is started from main pump controller use main pump controller to stop the engine.

If engine is started from engine gauge panel: Return **MODE SELECTOR** switch to **AUTOMATIC/MANUAL STOP** position, engine will stop. Close cooling system manual by-pass valve if opened.

IMPORTANT: DO NOT leave the **MODE SELECTOR** switch in the **MANUAL RUN** position during **AUTOMATIC** operation. (The controller will be unable to stop the engine and **DAMAGE MAY RESULT**).

Engines not equipped with an engine gauge panel, and LPCB engines, have a manual shutdown lever on the engine for shutdown.

2.6.4 Emergency Operation – ETR Engines Only

UL/FM Energized To Run (ETR) engines only

In the event that the speed switch fails to energize the engine's fuel injection pump solenoid, the engine instrument panel has been equipped with an Emergency Run Switch. This switch sends battery voltage directly to the fuel injection pump solenoid which allows for operation of the engine.

Additionally, the Emergency Run Switch will activate the engine raw water cooling loop solenoid if the engine is equipped with one.

If engine fails to run with standard starting procedures, follow these steps to start engine with Emergency Run Switch:

1. Open the door of the instrument panel
2. Locate the Emergency Run Switch, denoted by the yellow indication label
3. Remove the lock-out screw
4. Toggle switch to the ON position
 - a. Battery voltage will be sent to the fuel injection pump solenoid and the raw water cooling loop solenoid
5. To shut engine down ensure engine mode selector switch is set to Auto/Manual Stop, fire pump controller is keyed to OFF, and toggle the engine Emergency Run Switch to OFF position.

Note, activating the Emergency Run Switch will energize the fuel solenoid and the raw water cooling

loop solenoid until the switch is returned to the OFF position. The switch should only be used as a manual, emergency means for operation of the engine in the event of speed switch failure. Replace speed switch immediately upon finding failure.

3.0 ENGINE SYSTEMS

3.1 FUEL SYSTEM

3.1.1 Bleeding the Fuel System

CAUTION: Escaping fluid under pressure can penetrate the skin causing series injury. Relieve pressure before disconnecting fuel or other lines. Tighten all connections before applying pressure. Keep hands and body away from pinholes and nozzles, which eject fluids under high pressure. Use a piece of cardboard or paper to search for leaks. Do not use your hand.

If ANY fluid is injected into the skin, it must be surgically removed within a few hours by a doctor familiar with this type injury or gangrene may result. Doctors unfamiliar with this type of injury may call the Deere & Company Medical Department in Moline, Illinois, or other knowledgeable medical source. Ref figure #10

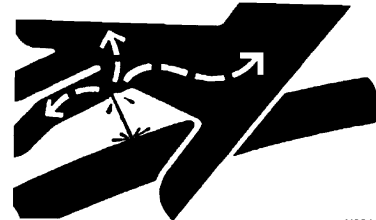

Figure #10

Whenever the fuel system has been opened up for service (lines disconnected or filters removed), it will be necessary to bleed air from the system.

3.1.1.1 JU4/6-UF,NL Engine Series:

- 1) Loosen the air bleed vent screw (A) two full turns by hand on fuel filter base. Ref. Figure #11
- 2) Operate supply pump primer lever (B) until fuel flow is free from air bubbles. Ref. Figure #12.
- 3) Tighten bleed plug securely; continue operating hand primer until pump action is not felt. Push hand primer inward (toward engine) as far as it will go.

4) Start engine and check for leaks.



Figure #11

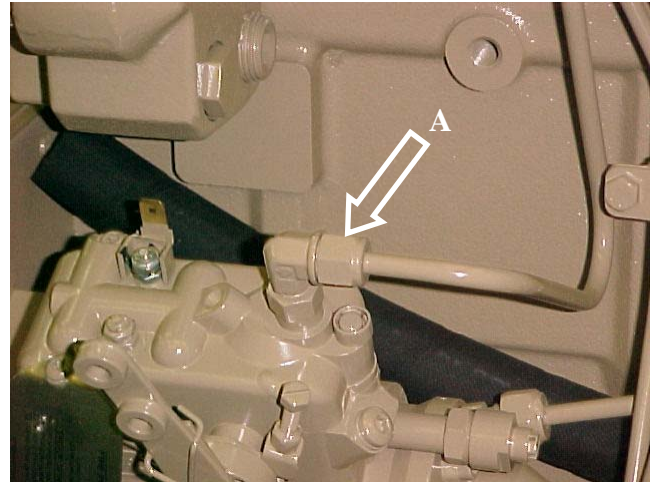

Figure #13

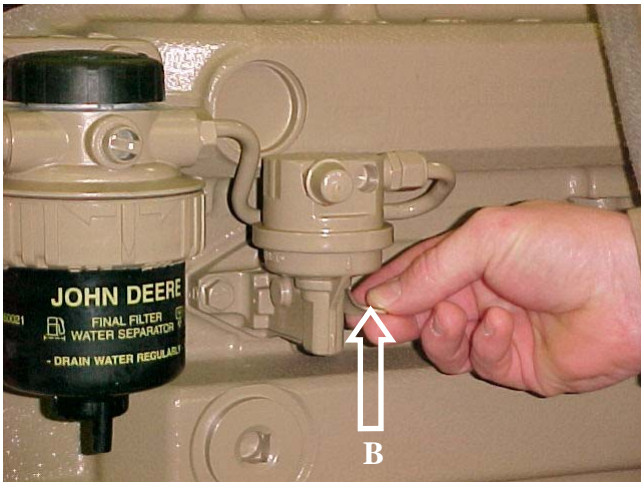

Figure #12



Figure #14

If engine will not start, it may be necessary to bleed air from fuel system at fuel injection pump or injection nozzles as explained next.

At Fuel Injection Pump:

- 1) Slightly loosen fuel return line connector (A) at fuel injection pump. Ref *figure #13*
- 2) Operate fuel supply pump primer lever until fuel, without air bubbles, flows from fuel return line connection.
- 3) Tighten return line connector at 16N-m (12 lb-ft).
- 4) Leave hand primer in the inward position toward cylinder block. Ref. *Figure #14*.

3.1.1.2 JU4/6 LP Engine Series

Photo to follow later

3.1.1.3 JDFP/JW6 Engine Series:

Refer to *Figure #19* for system components location.

- A – Primary Fuel Filter
- B – Secondary Fuel Filter
- C – Fuel Injection Pump
- D – Speed Adjustment

At Round Primary Fuel Filter/Water Separator:

- 1) Drain water and contaminants from clear sediment bowl.
- 2) Loosen air bleed vent screw (A) on fuel filter base (*Figure# 15*)

- 3) Operate and primer (B) until fuel flow is free from air bubbles (*Figure#15*)
- 4) Tighten vent screw as hand primer is held in downward pumping position.

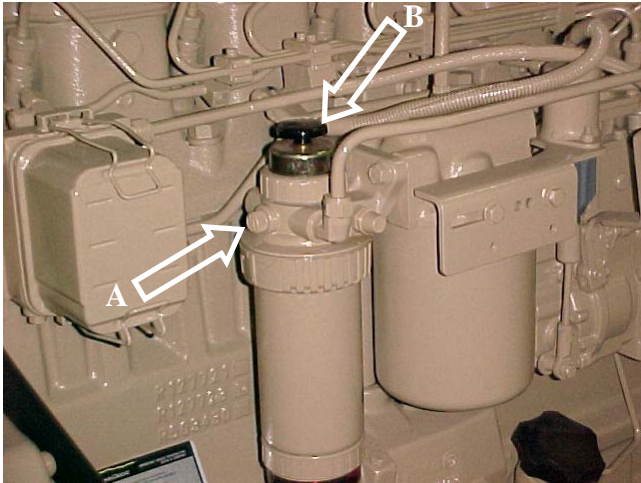

Figure # 15

At Rectangular Final Fuel Filter:

- 1) Loose bleed plug (A) on fuel filter base (*figure#16*).
- 2) Operate hand primer (B) on fuel supply pump (*figure#17*), until a smooth flow of fuel, free of bubbling, comes out of the plug hole.
- 3) Simultaneously stroke the hand primer down and close the filter port plug. This prevents air from entering the system. Tighten plug securely. DO NOT over tighten.
- 4) Start engine and check for leaks.

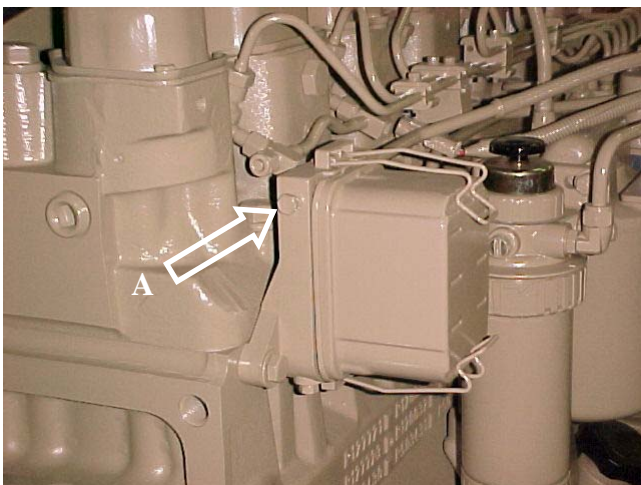

Figure #16

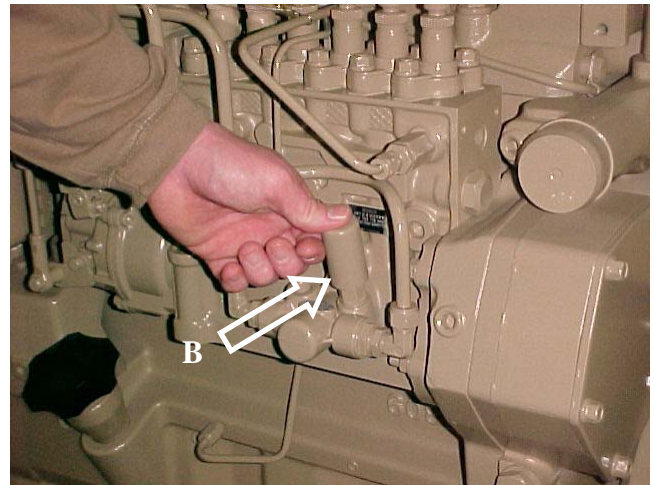

Figure #17

If engine will not start, it may be necessary to bleed air from fuel system at injection nozzles as explained below.

At Fuel Injection Nozzle

- 1) Loosen fuel line connection at no. 1 injection nozzle (A) (*figure#18*)
- 2) Crank engine with starting motor (but do not start engine), until fuel free from bubbles flows out of loosened connections. Retighten connection.
- 3) Start engine and check for leaks.
- 4) If engine does not start, repeat procedure at remaining injection nozzles (if necessary) until enough air has been removed from fuel system to allow engine to start.

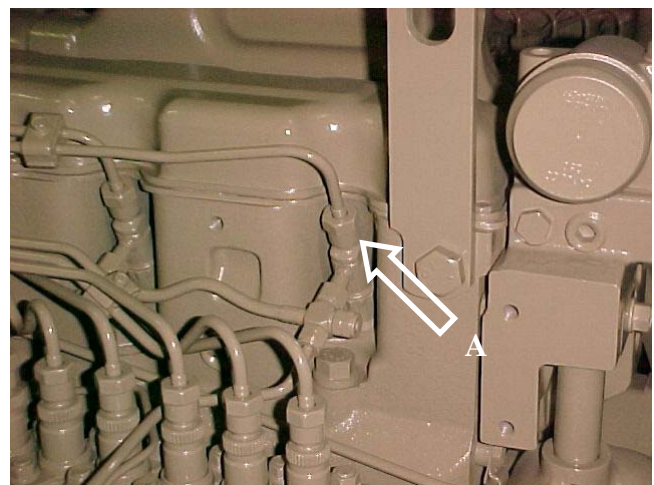

Figure #18

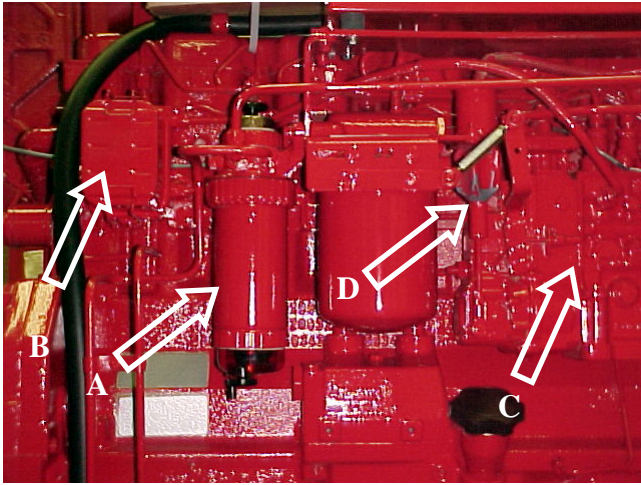

Figure #19

3.1.2 Draining the Condensate from the Fuel Filter

Drain the condensate from the fuel filter. Fuel filters have a drain (B) located at the bottom of their body (A) *figure#20*, these filters should be drained each week to relieve built up water.

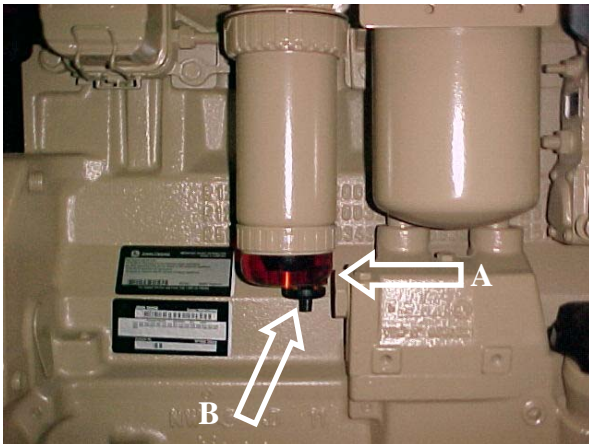

Figure #20

3.1.3 Changing the Fuel Filter Cartridges

Changing the cartridges and bleed any air from the fuel system as per instructions given in section 3.1.1. Fuel filter changes should take place as per recommendations and only using approved filters. It may also be necessary to change filters out with the recommendations in the event of:

- 1) The engine has had an overhaul.
- 2) The quality of the fuel is questionable.
- 3) The engine has been subjected to temporary adverse conditions outwith it normal operating parameters.

- 4) The fuel tank condensation trap has not been drained in line with manufacturer's recommendations.

3.1.3.1 JU4/6-UF,NL Engine Series

- 1) Close fuel shut-off valve, if equipped
- 2) Thoroughly clean fuel filter assembly and surrounded area.
- 3) Loosen drain plug (C) and drain fuel into a suitable container. Ref *figure#21*

Note: Lifting up on retaining ring and rotate it helps to get past raised locators.

- 4) Firmly grasp the retaining ring (A) and rotate it counterclockwise $\frac{1}{4}$ turn. Remove ring with filter element (B). Ref *figure#21*
- 5) Inspect filter mounting base for cleanliness. Clean as required.

Note: Raised locators on fuel filter canister must be indexed properly with slots in mounting base for correct installation.

- 6) Install new filter element onto mounting base. Be sure element is properly indexed and firmly seated on base. It may be necessary to rotate filter for correct alignment.

If equipped with water separator, remove filter element from water separator bowl. Drain and clean separator bowl. Dry with compressed air. Install water separator bowl onto new element. Tighten securely.

- 7) Align keys on filter element with slots in filter base.
- 8) Install retaining ring onto mounting base making certain dust seal is in place on filter base. Hand tighten ring (about $\frac{1}{3}$ turn) until it "snaps" into the detent. DO NOT over tighten retaining ring.

Note: The proper installation is indicated when a "click" is heard and a release of the retaining ring is felt.

A plug is provided with the new element for plugging the used element.

- Open fuel shut-off valve and bleed the fuel system. Tighten bleed plug (D). Reference *Figure #21*

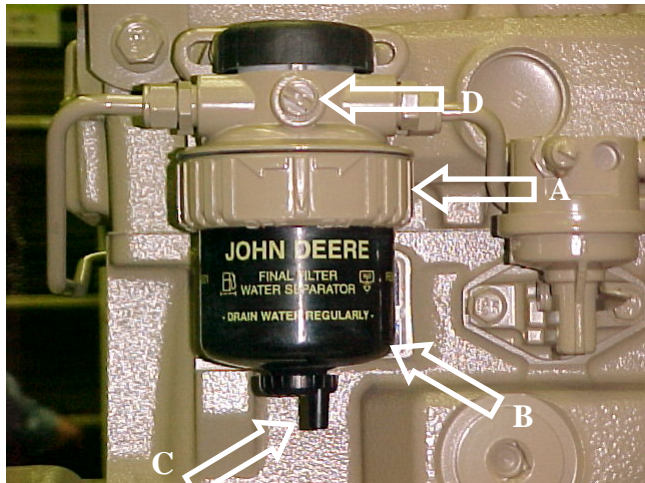

Figure #21

3.1.3.2 JU4/6 LP Engine Series

3.1.3.3 JDFP/JW6 Engine Series

Each engine has two fuel filters. For the purpose of identity, the primary filter incorporates the transparent water separator.

Replacing (round) Primary Fuel Filter/Water Separator

- Close fuel shut-off valve at bottom of fuel tank, if equipped.
- Thoroughly clean fuel filter/water separator assembly and surrounding area.

Note: Lifting up on retaining ring (F) as it is rotated helps to get it past retaining dent. Ref. *Figure #22*

- Rotate retaining ring counterclockwise $\frac{1}{4}$ turn. Remove ring with filter element.
- Remove water separator bowl (G) from filter element (E). Drain and clean separator bowl. Dry with compressed air. Ref. *Figure #22*

Note: Notice raised locators on filter element. These locators insure proper alignment of filter element to filter base.

- Install water separator bowl onto new filter element. Tighten securely.
- Index filter element until longer, vertical locator (D) is oriented opposite mounting base. Insert filter element into base securely.

It may be necessary to rotate filter for correct alignment. Ref. *Figure #22*

- Install retaining ring to filter base, making certain dust seal (C) is in place on filter base. Tighten retaining ring until it locks into detent position and a “click” sound can be heard. Ref. *Figure #22*
- Bleed fuel system.

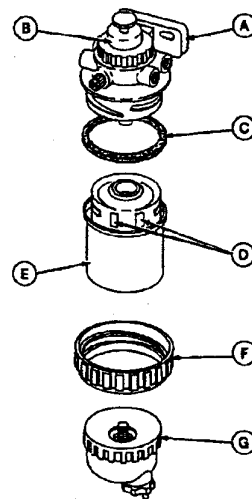

- A — Mounting Base
- B — Hand Primer
- C — Dust Seal
- D — Vertical Locators
- E — Filter Element
- F — Retaining Ring
- G — Water Separator Bowl

Figure #22

Replacing (rectangular) Secondary Fuel Filter Element

- Close fuel shut-off valve at bottom of fuel tank, if equipped.
- Loosen bleed plug (C) on side of filter base. Remove drain plug (B) to drain from fuel filter. Ref. *Figure #23*

Note: Keep a small container under drain plug to catch draining fuel.

- With fuel filter firm against base, lift up on top retaining spring and pull down on bottom retaining spring. Pull fuel filter off guide pins of fuel filter base and discard.
- Install new fuel filter onto guide pins of fuel filter base. Hold filter firmly against base.
- Secure bottom filter retaining spring first, then secure top retaining spring (four arrows).

- 6) Install new drawn plug, shown installed. Tighten bleed plug and drain plug securely. Do not over tighten.
- 7) Open fuel shut-off valve and bleed the fuel system. Ref. *Figure #23*

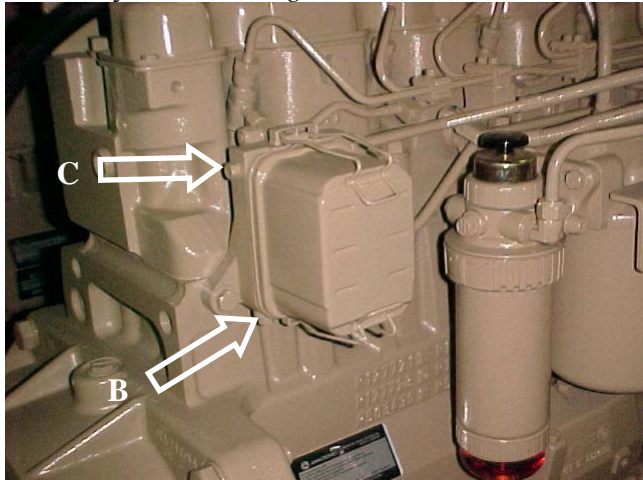

Figure #23

3.1.4 Fuel Tanks

Keep the fuel tank filled to reduce condensation to a minimum. Open drain at the bottom of the fuel tank once a week to drain off any possible water and/or sediment. Fill tank after each test run.

Note: Per NFPA 25 standards, the fuel tank level must never be less than 67% of its capacity.

Maximum Allowable Fuel Head above Fuel pump, Supply or Return.

Engine model	feet	meters
JU4 & JU6	4.5	1.4

3.1.5 JU4/6 Fuel Injection Pump Components

THIS TAG IS SUPPLIED ON ALL JU4 AND JU6 ENGINES

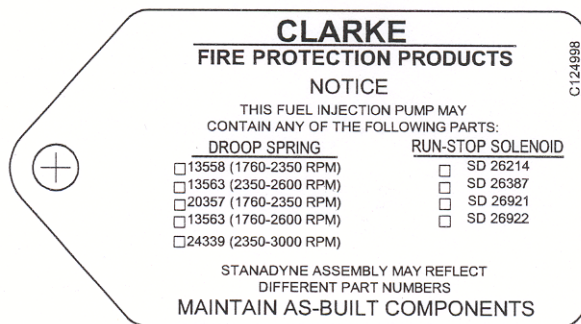

The above tag is stamped to identify the “As Built” Components. Refer to the next two tables to identify:

Table 1) Droop Spring Part Number by Engine Model and Speed.

Table 2) Run-Stop Solenoid (Internal to Injection Pump) Part Number by engine voltage.

Injection Pump “Droop Spring” Part Number

RPM	1760 2100 2350	2350 2600	2800 2960 3000
MODEL			
JU4H-UF10 JU4R-UF09 JU4R-UF11 JU4H-UF20 JU4R-UF19 JU4R-UF21 JU4H-LP20 JU4R-UF23 JU4H-UFADJ8 JU4H-UFADJ2 JU4H-UFAEA0 JU4H-UFAGE8 JU4H-UFAGE2 JU4R-UFAEA9 JU4R-UFAGE7 JU4R-UFAGE1	13563 or C02353		
JU4R-UF13 JU4H-UF14 JU4H-UF24 JU4H-UFAB26			24339
JU4H-UF12 JU4H-UF22 JU4H-UF32 JU4H-UF42 JU4R-UF51 JU4H-UF52 JU4H-UFH2		13563 or C02353	
JU4H-UF34 JU4H-UF44 JU4H-UF54 JU4R-UF53 JU4H-LP54 JU4H-LPL4 JU4H-UF84			24339
JU4H-UF30 JU4H-UF40 JU4R-UF40 JU4H-UF50 JU4H-UFH8 JU4H-UFH0 JU4H-UF58 JU4R-UF49 JU4H-LP50	20357		
JU6H-UF30 JU6H-UFD0 JU6H-UFG8 JU6H-UFABL0 JU6H-UFABL2 JU6H-UFABL8 JU6H-UFM8 JU6H-UFM0 JU6H-UF58 JU6H-UF50 JU6H-UF68 JU6H-UF60 JU6H-UFQAQ8 JU6H-UFQAAG JU6H-UFKAQ8 JU6H-UFKARG JU6H-UFAAPG JU6H-UFKAPG JU6H-UFQAS0 JU6H-UFKAS0 JU6H-LP50 JU6H-LP60 JU6R-UFQA29 JU6R-UFKA29 JU6R-UFQA09 JU6R-UFKAD9 JU6R-UFQA07 JU6R-UFKAG7 JU6R-UFQAL9 JU6R-UFKAL9	13558		

JU6R-UFAAL1 JU6R-UFKAL1 JU6R-UFAL7 JU6R-UFKAL7 JU6R-UFAAM7 JU6R-UFKAM7 JU6R-UFAAM9 JU6R-UFKAM9 JU6R-UFAA57 JU6R-UFKA57 JU6R-UFAA49 JU6R-UFKA49 JU6R-UFAA67 JU6R-UFKA67 JU6R-UFAA59 JU6R-UFKA59 JU6R-UFAAQ7 JU6R-UFKAQ7 JU6R-UFAARF JU6R-UFKARF JU6R-UFAAPF JU6R-UFKAPF JU6R-UFAAS9 JU6R-UFKAS9			
JU6H-UF32 JU6H-UFD2 JU6H-UFM2 JU6H-UF52 JU6H-UF62 JU6R-UFAA31 JU6R-UFKA31 JU6R-UFAAD1 JU6R-UFKAD1 JU6R-UFAAM1 JU6R-UFKAM1 JU6R-UFAA51 JU6R-UFKA51 JU6R-UFAA61 JU6R-UFKA61		13563 or C02353	
JU6H-UF34 JU6H-UF54 JU6H-UF84 JU6H-UFAB76 JU6R-UFAA33 JU6R-UFKA33 JU6R-UFAA53 JU6R-UFKA53 JU6R-UFAA83 JU6R-UFKA83			24339

Run-Stop Solenoid Part Number

	ETR	ETS
12 Volt	SD26214 or C07853	SD26921 or C07827
24 Volt	SD26387 or C07826	SD26922 or C07828

Legend:

- ETR – Energized to Run
- ETS – Energized to Stop
- SD # - Stanadyne Part Number
- C # - Clarke Part Number

3.1.6 JW6 Fuel Injection Pump Components

For Droop Spring and Run-Stop Solenoid (external to Injection Pump) part numbers consult factory.

3.2 AIR/EXHAUST SYSTEM

3.2.1 Ambient Conditions

Clarke engines are tested in accordance with SAE J1349 (Clarke USA) or ISO 3046 (Clarke UK). In this capacity they may be derated to meet certain site conditions, failure to do so can seriously impede the performance of the engine and could lead to premature failure.

3.2.2 Ventilation

The engine must be provided with adequate ventilation to satisfy the requirements of the combustion system, radiator cooling systems where fitted, and allow adequate dissipation of radiated heat and crankcase emissions. For all this data refer to Installation & Operation Data (see Page 5). This data can be used for proper sizing of inlet and outlet louvers.

3.2.3 Standard Air Cleaner

Base engine	Speed	Air filter restriction
All JU4		10
All JU6 except models below		12
UF30, UFABL8, UFM8, UF58, UF68, UFAAPG	1470	10
UFD0, UFD2, UF30, UF32, UFABL0, UFABL2, UFM0, UFM2, UF50, UF52, UF60, UF62	2350	13
UFD2, UF32, UFABL2, UFM2, UF52, UF62	2600	13

The standard air cleaner is a reusable type. Should a situation occur where the air cleaner becomes plugged with dirt (starving the engine of air), loss of power and heavy black smoke will result; the air cleaner should be serviced immediately. See *figure #39* for air cleaner part numbers by Clarke Engine Model.

CAUTION: Do not attempt to remove the air cleaner while an engine is running nor run the engine while the air cleaner is off. Exposed components could cause severe injury to personnel and major internal engine damage could occur should any foreign matter be drawn into the engine.

The air cleaner manufacturer recommends the following:

1. The pre-oiled reusable elements are serviced with a special oil. The elements can be serviced or replaced.
2. Figure #24 shows the air filter service instructions.
3. When servicing the element is not practical, you can improve filter efficiency by re-spraying with oil.

NOTE: Do not attempt this while engine is running
NOTE: Do not over oil the reusable element

9. OILING HINTS

Never use a **K&N** air filter without oil. *(The filter will not stop the dirt without the oil.)* Use only **K&N** formulated air filter oil.



K&N air filter oil is a compound of mineral and animal oil blended with special polymers to form a very efficient tack barrier. Red dye is added to show just where you have applied the oil. Eventually the red color will fade but the oil will remain and filter the air.

NEVER USE Automatic Transmission Fluid.
NEVER USE Motor Oil.
NEVER USE Diesel Fuel.
NEVER USE WD-40, LPS, or other light weight oils.

Figure #24

Note: Intake Air Shutoff Valve - Engine may include an intake air shutoff valve as an optional feature that is activated by an overspeed event and provides a positive shutoff of combustion air to the engine. The optional air intake shutoff valve has not been evaluated by UL as part of a UL Listed fire pump driver.

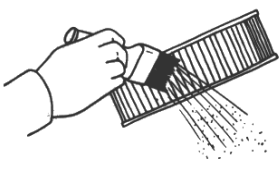
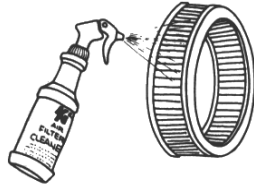
AIR FILTER SERVICE INSTRUCTIONS

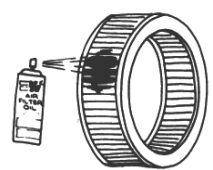
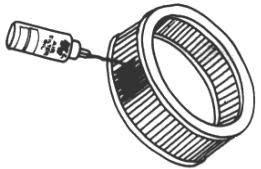
<p>1. PRE-CLEANING</p> <p>Tap the element to dislodge any large embedded dirt, then gently brush with a soft bristle brush. <i>(Note: If complete cleaning is not practical at this time, re-oil the element and re-install in your vehicle.)</i></p> 	<p>2. SPRAY ON CLEANER</p> <p>Spray K&N air filter cleaner liberally onto the entire element and let soak for 10 minutes.</p> 
<p>3. PAN CLEANING</p> <p>Large K&N elements can be rolled or soaked in a shallow pan of K&N air filter cleaner. Remove immediately and let soak for approximately 10 minutes.</p> 	<p>4. CLEANING HINTS</p> <p>Use only K&N air filter cleaner.</p> <p>NO gasoline cleaning. NO steam cleaning. NO caustic cleaning solutions. NO strong detergents. NO high pressure car wash. NO parts cleaning solvents.</p> <p>Any of these NO's can cause harm to the cotton filter media, plus shrink and harden the rubber end caps.</p>
<p>5. RINSE OFF</p> <p>Rinse off the element with low pressure water. Tap water is OK. Always flush from the clean side to dirty side. This removes the dirt and does not drive it into the filter.</p> 	<p>6. DRYING HINTS</p> <p>Always dry naturally. After rinsing, shake off all excess water and let the element dry naturally.</p> <p>DO NOT USE COMPRESSED AIR DO NOT USE OPEN FLAME DO NOT USE HEAT DRYERS</p> <p>EXCESS HEAT WILL SHRINK THE COTTON FILTER MEDIA.</p> <p>COMPRESSED AIR WILL BLOW HOLES IN THE ELEMENT.</p>
<p>7. AEROSOL OILING</p> <p>After cleaning air filter always re-oil before using. Spray K&N air filter oil down into each pleat with one pass per pleat. Wait 10 minutes and reoil any white spots still showing.</p> 	<p>8. SQUEEZE BOTTLE OILING</p> <p>After cleaning air filter always re-oil before using. Squeeze K&N air filter oil down into the bottom and along each pleat — only one pass per pleat. Let oil wick into cotton for 20 minutes. Re-oil any white spots still showing.</p> 

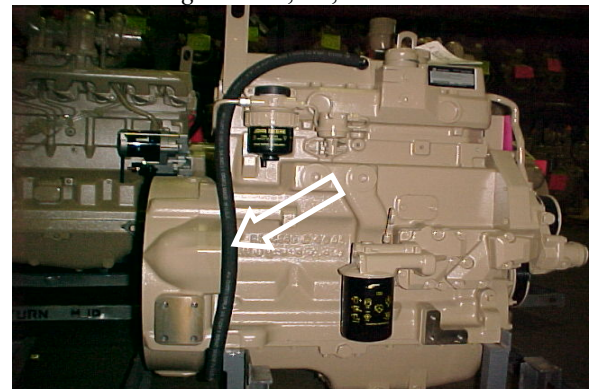

Figure #25

JU4H-UF10, 12, 20, 22, UFADA0, JU4-LP20, 24

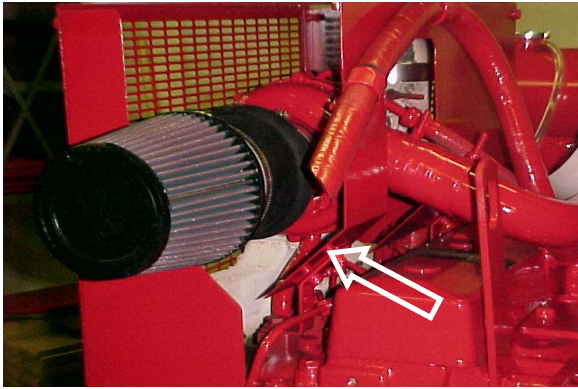

Figure #26

JU4H-UF30, 32, 40, 42, 50, 52, H8, H0, H2, 58, UFADJ8, ADJ2, ADE8, ADF2, ADHG, LP50, 54, & all JU6H

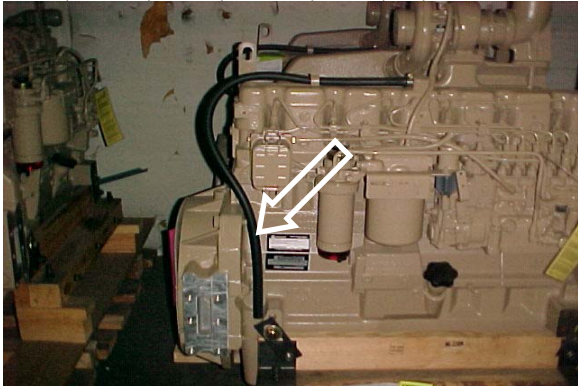

Figure #27 (JDFP/JW6H)

3.2.4.2 Crankcase Ventilation System

A crankcase ventilation system allows for the recirculation of vapors (expelled through a vent pipe attached to the rocker cover breather element) to the combustion air inlet. Refer to *figure 27a*.



Figure #27a

Engine Model	Open Crankcase Ventilation	Crankcase Ventilation System
All Models	Standard	Optional

Figure #27b

3.2.5 Exhaust System

Excessive back pressures to the engine exhaust can considerably reduce both engine performance and life. It is therefore important that exhaust systems should be the proper diameter and be as short as possible within the minimum amount of bends. Refer to Installation & Operating Data (see Page 5) for exhaust data. Also refer to table below for maximum exhaust restriction.

Base engine	Speed	Exhaust backpressure limit
All JU4		30
All JU6 except models below		30
UF34, UF54, UFAB76, UF84	2800	25
UF34, UF54, UF84	3000	25
UF30, UFG8, UFABL8, UFM8, UF58, UF68, UFAAPG	1470	20

The installation of the exhaust system should consist of the following:

- Personnel protection from hot surfaces.
- Adequate supports to prevent strain on the engine exhaust outlet and minimize vibration.
- Protection against entry of water and other foreign matter.

While the engine is running inspect exhaust pipe outlet outside of the pump room itself for environmental hazards such as excessive smoke conditions. The following could be used as a guide for general engine operating conditions.

- 1) Blue Smoke – Possible engine oil consumption.

- 2) White Smoke – Possibility of water in cylinders, water in fuel or internal engine problem.

3.3 LUBRICATION SYSTEM

3.3.1 Checking Sump Oil

Check the sump oil level using the dipstick on the engine as shown in *Figure #28 & 29*.

This level must always be between the dipstick marks Min. and Max. with the engine not running.

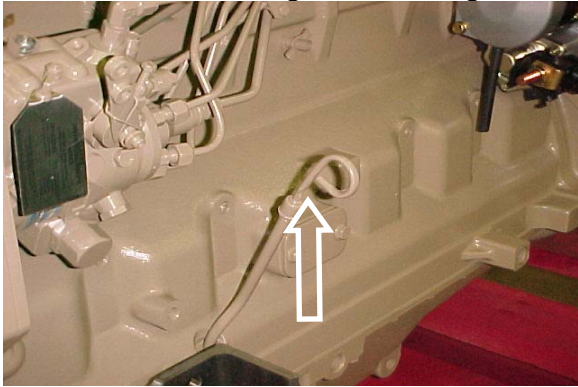

Figure #28
JU4/6

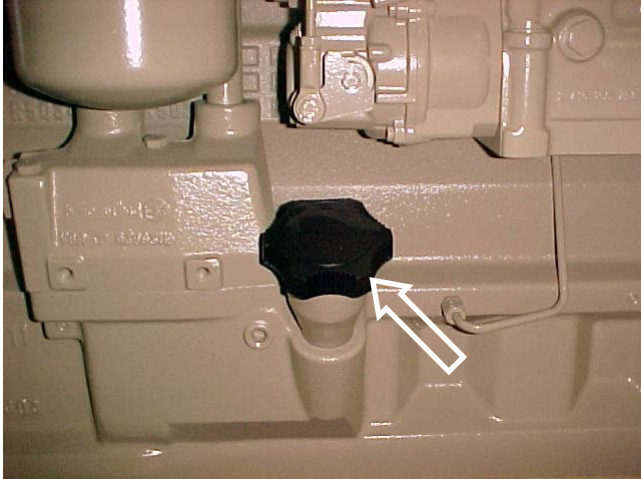

Figure #29
JDFP/JW6

3.3.2 Changing Engine Oil

- 1) Operate the engine until it is warm.
- 2) Stop the engine. Remove the sump drain plug and drain the lubricating oil from the sump. Fit the drain plug tighten the plug to 34 Nm (25lbf-ft) / 3.5 kgf-m.

- 3) Fill the sump to the ‘FULL’ mark on the dipstick with new and clean lubricating oil of an approved grade.
- 4) Return the unit back into service by returning the AEC selector to “automatic” position and the manual operating lever to manual stop position.
- 5) Dispose used oil properly.

3.3.3 Changing Oil Filter Cartridge

1. Turn engine off.
2. Put a tray under the filter to retain spilt lubricating oil.
3. Remove the filter with a strap wrench or similar tool. Then dispose of the filter properly (Ref *Figure #30*).
4. Clean the filter head.
5. Add clean engine lubricating oil to the new filter. Allow the oil enough time to pass through the filter element.
6. Lubricate the top of the filter seal with clean engine lubricating oil.
7. Fit the new filter and tighten it by hand only. Do not use a strap wrench.
8. Ensure that there is lubricating oil in the sump. On turbocharged engines, ensure that the engine will not start and operate the starter motor until oil pressure is obtained.
9. Operate the engine and check for leakage from the filter. When the engine has cooled, check the oil level on the dipstick and put more oil into the sump, if necessary.
10. Return the unit back into service by returning the main pump controller selector to “automatic” position and the manual operating lever to AUTO-OFF position.



Figure #30

3.3.4 Oil Specification

This engine is factory-filled with John Deere Engine Break-in Oil.

Important: Do not add makeup oil until the oil level is BELOW the add mark on the dipstick.

Break-in period is 1 year from engine start-up.

Low Speed engine models (Nameplate RPM is less than or equal to 2600 RPM) are shipped from Clarke with John Deere Break-in oil installed. Break-In Oil (TY22041, 10W30) should be used to make up any oil consumed during the break-in period.

High speed engine models (Nameplate RPM is greater than 2600 RPM) are shipped with CI-4, 15W40 oil. On these models any make up oil should meet the requirements of CF-4, CG-4, CH-4, or CI-4, Viscosity Grade 15W40.

Oil spec to be used after break-in period, all engine models:

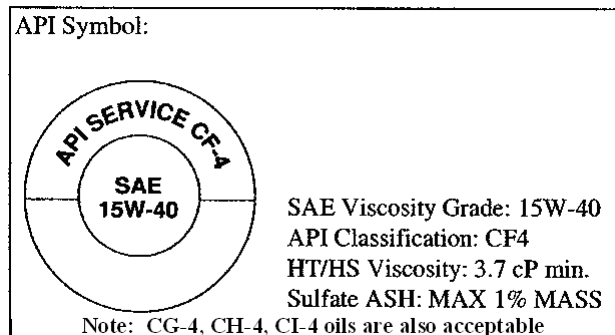

Figure #31

3.3.5 Oil Capacities (Including Filter)

ENGINE MODEL	OIL CAPACITY QUARTS (LITERS)
JU4 – All Models	15.5 (14.7)
JU6 – All Models (except JU6H-UFAARG, KARG, AAPG, KAPG, AAS0, KAS0, AAQ8, KAQ8, JU6R-UFAARF, KARF, AAPF, KAPF, AAS9, KAS9, AAQ7, KAQ7)	21.1 (20.0)
JU6H-UFAARG, KARG, AAPG, KAPG, AAS0, KAS0, AAQ8, KAQ8, JU6R-UFAARF, KARF, AAPF, KAPF, AAS9, KAS9, AAQ7, KAQ7	34.3 (32.5)
JW6 – All Models	30.1 (28.5)

Figure #32

3.4 COOLING SYSTEM

3.4.1 Intended Engine Operating Temperature

The JU and JW engines are provided with either a heat exchanger or radiator to maintain the engine coolant temperature within recommended operating guidelines.

The JU4H, JU6H, and JW6H have an intended engine operating temperature of 160° F (71°C) to 185° F (85° C). A high coolant temperature switch is provided to indicate a high coolant temperature alarm at 205° F (96° C) for heat exchanger cooled models and 215°F (102° C) for radiator cooled models.

3.4.2 Engine Coolant

The following information is provided as a guide for John Deere Engine users in the selection of a suitable coolant.

The water/ethylene glycol/inhibitor coolant mixture used in John Deere engines must meet the following basic requirements:

- Provide for adequate heat transfer.
- Provide protection from cavitation damage.
- Provide a corrosion/erosion-resistant environment within the cooling system.
- Prevent formation of scale or sludge deposits in the cooling system.
- Be compatible with engine hose and seal materials.
- Provide adequate freeze and boil over protection.

WARNING

A water and anti-freeze solution is required for pump installations. Premixing this solution prior to installing is required. This prevents possible pure anti-freeze chemical reactions to block heater elements which can burnout the element. Please see the I&O section (see Page 5) for proper cooling system capacities of each model.

3.4.3 Water

Water can produce a corrosive environment in the cooling system, and the mineral content may permit scale deposits to form on internal cooling surfaces. Therefore, inhibitors must be added to control corrosion, cavitation, and scale deposits.

Chlorides, sulfates, magnesium and calcium are among the materials which make up dissolved solids that may cause scale deposits, sludge deposits, corrosion or a combination of these. Chlorides and/or sulfates tend to accelerate corrosion, while hardness (percentage of magnesium and calcium salts broadly classified as carbonates) causes deposits of scale. Water within the limits specified in *figure #33* is satisfactory as an engine coolant when properly inhibited. Use of distilled water is preferred.

Materials	Parts per Million	Grains per Gallon
Chloride (Max.)	40	2.5
Sulfates (Max.)	100	5.8
Total Dissolves Solids (Max.)	340	20
Total Hardness (Max.)	170	10

Figure #33

3.4.4 Coolant Capacities

Use an ethylene glycol coolant (low silicate formulation) that meets the standard of either the GM 6038-N formulation (GM1899-M performance) or **ASTM D-6210** requirements.

A 50% coolant water solution is recommended. A concentration over 70% is not recommended because of poor heat transfer capability, adverse freeze protection and possible silicate dropout. Concentrations below 30% offer little freeze, boil over or corrosion protection.

IMPORTANT

Never use automotive-type coolants (such as those meeting only ASTM D3306 or ASTM D4656). These coolants do not contain the correct additives to protect heavy-duty diesel engines. They often contain a high concentration of silicates and may damage the engine or cooling system.

ENGINE MODEL	COOLANT CAPACITY QUARTS (LITERS)
JU4H naturally aspirated, low speed (<2600 rpm)	15.3 (14.5)
JU4H naturally aspirated, high speed (>2600 rpm)	15.9 (15)
JU4H turbocharged, low speed (<2600 rpm)	15.3 (14.5)
JU4H turbocharged, high speed (>2600 rpm)	14.8 (14)
JU4R naturally aspirated, low speed (<2600 rpm)	19.0 (18.0)

JU4R naturally aspirated, high speed (>2600 rpm)	19.6 (18.5)
JU4R turbocharged, low speed (<2600 rpm)	20.0 (19.0)
JU4R turbocharged, high speed (>2600 rpm)	19.5 (18.5)
JU6H low speed (<2600 rpm)	19.5 (18.5)
JU6H high speed (>2600 rpm)	20.0 (19.0)
JU6R turbocharged, low speed (<2600 rpm)	42.5 (40.2)
JU6R turbocharged, high speed (>2600 rpm)	43.0 (40.7)
JU6R turbocharged & aftercooled, low speed (<2600 rpm)	37.5
JU6R turbocharged & aftercooled, high speed (>2600 rpm)	38.0
JDFP-06WA/JW6H-UF30,38	22 (21)
JDFP-06WR/JW6H-UF40,48, 50, 58, 60, H8	23 (22)

Figure #34

3.4.5 Coolant Inhibitor

The importance of a properly inhibited coolant cannot be over-emphasized. A coolant which has insufficient or no inhibitors at all, invites the formation of rust, scale, sludge and mineral deposits. These deposits can greatly reduce the cooling systems efficiency and protection capabilities.

Recommended supplemental coolant inhibitors are a combination of chemical compounds which provide corrosion protection, cavitation suppression, pH controls and prevents scale. These inhibitors are available in various forms, such as liquid packages or integral parts of anti-freeze.

It is imperative that supplemental inhibitors be added to all John Deere engine systems. A pre-charge dosage must be used at the initial fill and the maintenance dosage used at each service interval. Serious damage will occur unless inhibitors are used. Some of the more common corrosion inhibitors are borates, nitrates and silicates. Inhibitors become depleted through normal operation; additional inhibitors must be added to the coolant as required to maintain original strength levels. Refer *Figure #35* for proper concentrations of inhibitors.

	Min. PPM	Max PPM
Boron (B)	1000	1500
Nitrite (NO ²)	800	2400
Nitrates (NO ³)	1000	2000
Silicon (Si)	50	250
Phosphorous (P)	300	500
PH	8.5	10.5

Figure #35

Do not use soluble oils or chromate inhibitors in John Deere engines. Detrimental effects will occur. To properly check inhibitor concentrations it may be necessary to contact your local Service/Dealer for assistance. Refer to Parts Information Section to obtain the part number for the factory Coolant Analysis Kit. This kit can be purchased for a nominal fee for analyzing the conditions of the engine's coolant.

3.4.6 Procedure for Filling Engine

During filling of the cooling system, air pockets may form. The system must be purged of air prior to being put in service. This is best accomplished by filling with a pre-mix solution.

Caution: Do not overfill cooling system. A pressurized system needs space for heat expansion without overflowing.

3.4.6.1 Engines without Coolant Recovery Tank (Figure #35A)

Install the pressure cap, start and run engine for approximately 5 minutes in order to purge the air from the engine cavities.

When verifying that the coolant is at a safe operating level, it is best to wait until the engine temperature drops to approximately 120°F (49°C), or lower, before removing the pressure cap.

Remove the pressure cap and refill to the proper fill level. To continue the deaeration process start and run engine until the temperature stabilizes at approximately 160°-200° (71°-93° C) or run engine for 25 minutes, whichever is longer. During this warming process, you may see coolant coming from the overflow tube attached at the pressure cap location. Allow engine to cool, then remove the pressure cap and refill to the proper fill level.

Caution: Do not remove pressure cap while coolant is at normal operating temperatures. Possible personal injury could result from the expulsion of hot coolant.

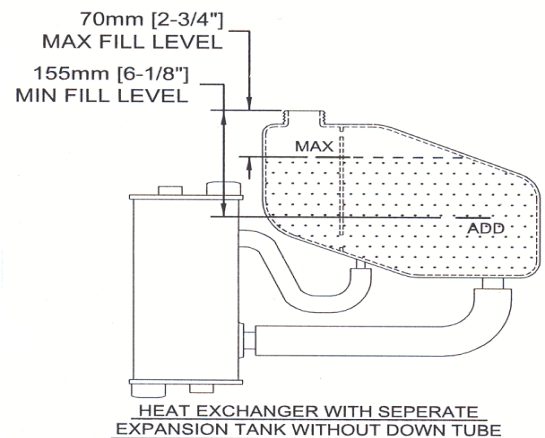
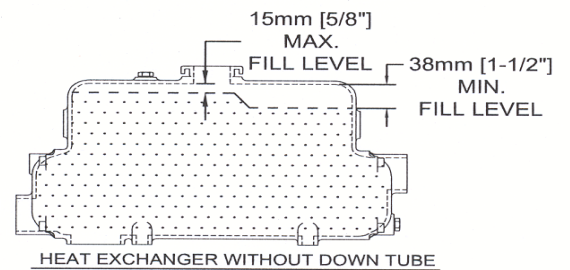
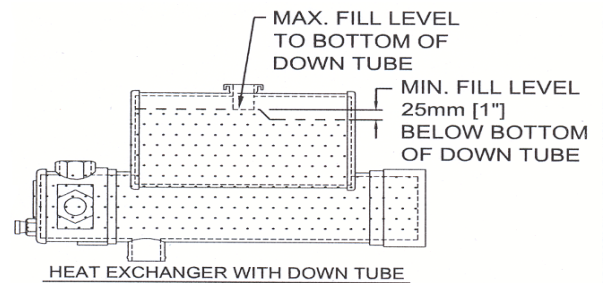
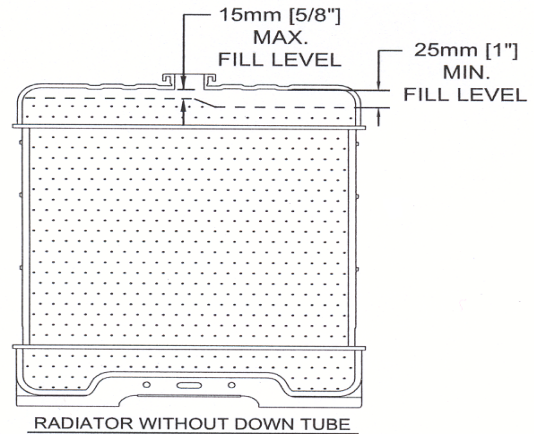

Figure #35A

3.4.6.2 Engines with Coolant Recovery Tank (Figure #35B & #35C)

Remove pressure cap from heat exchanger and fill the cooling system with a 50/50 coolant mixture to pressure cap sealing surface.

Note: Use a fill rate of no more than 10 liters/min (3 gpm). Replace heat exchanger pressure cap.

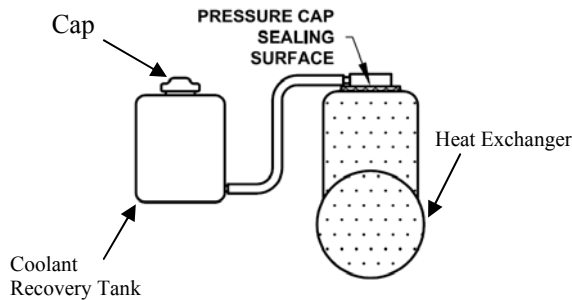

Figure #35B

Remove cap from coolant recovery tank and fill the coolant recovery tank with a 50/50 coolant mixture to a level of 100mm (4") from bottom of the tank. Replace cap.

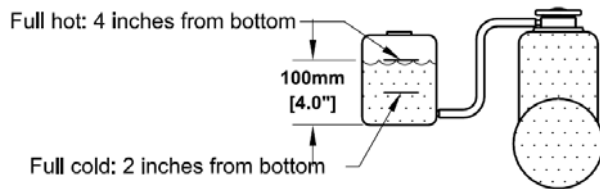

Figure #35C

Start and run engine with fire pump in a no flow or low flow condition. Run engine for approximately 1 minute. Carefully remove heat exchanger pressure cap while engine is running.

Note: Caution should always be taken when removing a cap from a system under pressure.

Refill cooling system to the pressure cap sealing surface. Replace heat exchanger pressure cap.

Complete deaeration will take several warm up/ cool down cycles. Always check appropriate coolant level in coolant recovery bottle.

3.4.7 Providing adequate Raw Water Supply to the Engine Heat Exchanger

3.4.7.1 Raw Water Supply

Most Clarke diesel engine fire pump drivers are heat exchanger cooled and some engines also have a charge air cooler (CAC) that uses raw water to cool the air before entering the intake manifold. If you have a radiator cooled Clarke engine, you can disregard this section. Heat exchanger cooled diesel engine drivers require a clean source of pressurized water from the discharge side of the fire pump in order to keep the engine from overheating by providing a specified minimum amount of raw water flow.

3.4.7.2 Cooling Loop

Note: Engine may include a cooling loop as an optional feature and has not been evaluated by UL as part of a UL Listed fire pump driver.

Figure #35D shows the standard NFPA 20 cooling loop piping arrangement. The cooling loop consists of an Automatic flow line with a 12V or 24V solenoid valve (HSC and ES pump applications only) that is energized to open anytime the engine is called upon to run from either the fire pump controller or from the engine instrument panel.

NOTE: VT type pumps applications do not require a solenoid valve in the Automatic flow line.

NOTE: With the Mechanical Engine and Alarm Control Board, See section 3.5.5, the solenoid valve will open 15 seconds after engine shutdown and will stay open for 60 seconds. This allows for raw water to flow through the heat exchanger and reduce the heat soak rise caused in the engine.

The second flow line is called the Manual by-pass line and it can be opened at any time if for any reason the engine shows signs of overheating. Each line has two (quarter turn) shutoff valves installed and the normal position of the shutoff valve is to remain open in the Automatic flow line and remain closed in the Manual by-pass flow line.

NOTE: Opening up both lines to flow is never a problem should there be some concern of engine overheat, especially if there is an emergency situation. The Manual by-pass line can only be opened by an operator in the pump room.

The shutoff valves are all identified to show which are Normally Open (Automatic flow line) and which

are Normally Closed (Manual by-pass flow line). The shutoff valves are also used to isolate water pressure in the event of maintenance to pressure regulators, strainers and solenoid valve. Shutoff valves in the automatic flow line are provided with lockable handles for cooling loops that have been tested to FM requirements.

In each flow line there is also a pressure regulator. Each pressure regulator protects the downstream piping from over-pressurization which includes the tube side of the engine shell & tube heat exchanger (or CAC) and to control raw water flow rate. Typically the pressure regulators are set to limit downstream pressure to 60 psi (4 bar). There is a

pressure gauge installed just upstream of the engine heat exchanger (or CAC) and downstream of the each pressure regulator. Under normal engine operating conditions with adequate cooling water flowing thru the heat exchanger (or CAC) this gauge should typically read below 20 psi (1.4 Bar).

Strainers are used to remove debris from the raw water supply. One strainer is in the Automatic flow line and the other is in the Manual by-pass flow line. Note: See section 3.4.7.5 regarding strainer maintenance.

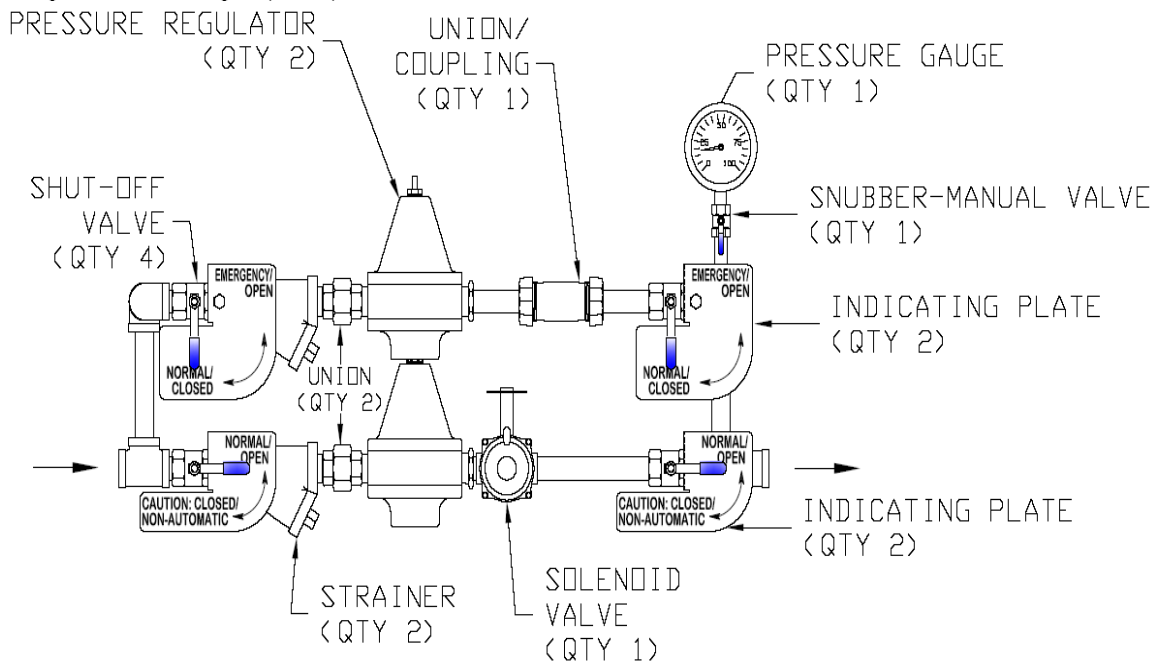

STANDARD COOLING LOOP

Figure #35D

3.4.7.3 Setting Raw Water Flow Rate

The proper amount of raw water flow thru this line is of the utmost importance, and the pressure gauge value does little to indicate if there is sufficient flow. When the engine is exercised weekly, the amount of raw water flow exiting the piping to a floor drain should always be checked to verify it does not appear to have diminished.

During initial commissioning of the engine, it is important to correctly set the raw flow rate going thru the cooling loop. Each Clarke engine model has an Installation and Operation (I&O) Datasheet that

provides basic operating conditions of the engine and most values are given based upon engine speed. You will find this datasheet in the Operators Manual that is shipped with the engine for your specific Clarke model. This datasheet must be available during commissioning in order to set the proper minimum raw water flow. You will need to measure the raw water temperature and then find the value for recommended minimum raw water flow at your

measured raw water temperature on the I&O Datasheet and then; with the fire pump flowing 150% of rated flow, and the Automatic flow line open; set minimum flow by using the adjusting screw at the top of the pressure regulator.

NOTE: To increase flow turn the adjusting screw clockwise and to reduce flow turn the adjusting screw counterclockwise.

You will need to capture the flow for a specific amount of time coming out of the heat exchanger and going to a floor drain in order to establish a reasonably accurate flow rate value. Using a container or bucket of known volume, record the time required to fill the container and compare to the gpm or L/min value provided on the I&O datasheet. ***THIS IS CRITICAL FOR PROPER ENGINE COOLING AT MAXIMUM PUMP LOAD!*** After setting the pressure regulator in the Automatic flowline, open the Manual by-pass line valves, and then close the Automatic flowline valves and repeat the above process in order to set the flowrate going thru the pressure regulator in the Manual by-pass line. Once this is completed; close the Manual by-pass valves and open the Automatic flowline valves to restore conditions back to normal.

3.4.7.4 Raw Water Outlet

NOTE: NFPA 20 does allow for the heat exchanger outlet flow to be returned to a suction reservoir. This makes it very difficult to measure the flowrate. When discharging to a suction reservoir, NFPA provides additional requirements:

- 1) A visual flow indicator and temperature indicator are installed in the discharge (waste outlet) piping.
- 2) When waste outlet piping is longer than 15ft (4.6m) and / or the outlet discharges are more than 4ft (1.2M) higher than the heat exchanger, the pipe size increased by at least one size.
- 3) Verify that when the correct flow rate is achieved that the inlet pressure to the heat exchanger (or CAC) does not exceed 60psi (4bar)

If you have such an installation, it is recommended that you run the engine for a period of time at firepump 150% flow and confirm the visual flow indicator is showing water flow, the temperature rise

is not excessive (usually no more than 40F (4.5C) over ambient raw water temperature) and the engine is showing no signs of overheating.

3.4.7.5 Raw Water Quality, Strainers and Deterioration of Heat Exchanger (or CAC)

Over time, as the heat exchanger (or CAC) begins to plug and foul, this pressure will rise and the flow will diminish which could mean that the heat exchanger (or CAC) may have to be replaced.

It can be not stressed enough how important it is to keep these strainers clean: ***Most engine failures occur due to plugged cooling loop strainers!*** If the raw water supply has debris in it (leaves, stones, etc) as the strainer accumulates more debris (that will not pass thru it), the flowrate will continue to diminish which will eventually starve the engine of adequate cooling water flow which will lead to engine overheat and catastrophic engine failure. ***When this occurs you have no fire protection!*** Clarke recommends that after the initial engine commissioning and also prior to each weekly exercise of the engine / fire pump set, both strainers be removed and cleaned and then re-installed before starting the engine.

3.4.7.6 Backflow Preventers

NFPA20 allows for the use of backflow preventers in the Automatic and Manual flow line of the cooling loop as required by local code. For specific application information contact factory.

3.4.7.7 Raw Water Outlet Temperature

Certain local codes may not allow you to discharge the waste water outlet from the engine heat exchanger either due to its temperature or it now being considered hazardous waste. It is recommended you always check local codes regarding waste water discharge.

3.4.8 Flow Paths of Engine Cooling System

The engine coolant flows through the shell side of the heat exchanger (or radiator), engine coolant pump, oil cooler, engine block and cylinder head, jacket water heater, thermostat, expansion tank, and coolant recovery tank (if equipped).

On heat exchanger equipped engines raw cooling water flows through the tube side of the charge air

cooler, if equipped, and the tube side of the heat exchanger.

Refer to *Figures #35E* for heat exchanger cooled engines and *#35F* for radiator cooled engines for cooling system flow path diagrams.

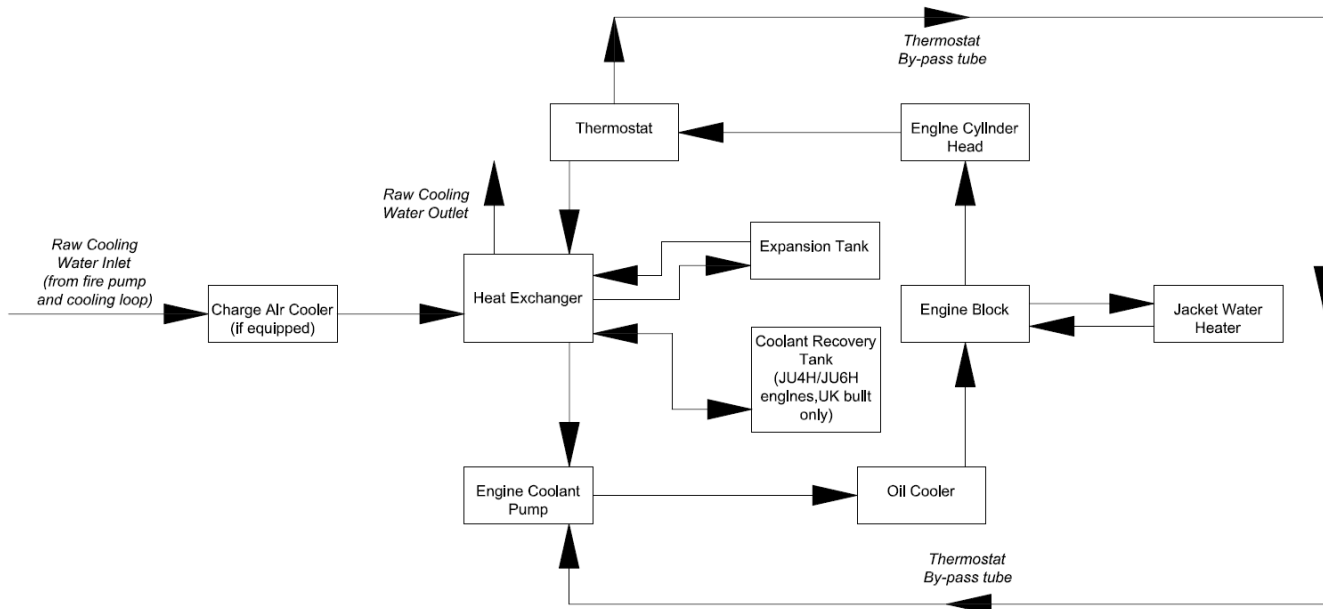

Figure 35E – Heat Exchanger cooled engines

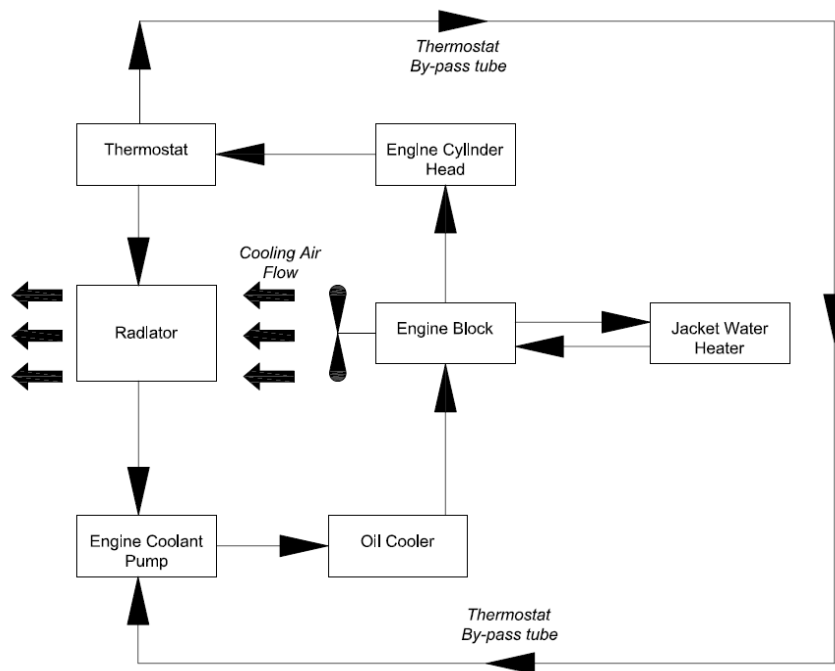

Figure 35F- radiator cooled engines

3.4.9 IMPORTANT SERVICE NOTICE

Any time an engine experiences a high coolant temperature alarm condition the primary cause of the overheat must be determined and the cause corrected to prevent a recurring overheat event.. Additionally,

if an event of a restricted flow, collapsed hose, insufficient coolant level or failed pressure cap is experienced, further investigation of the cooling system is required.

- 1) The coolant should be drained (after de-energizing the coolant heater)
- 2) Replace the engine thermostat(s)
- 3) Remove the engine water pump and inspect the impeller and seal for damage, replace as necessary. Reassemble and refill coolant according to the Installation and Operations Instruction Manual.
- 4) Run the engine to verify normal operating temperature.

3.4.9.1 Water Pump Cavitation

Cavitation is a condition that occurs when bubbles form in the coolant flow in the low pressure areas of the cooling system and implode as they pass to the higher pressure areas of the system. This can result in damage to cooling system components, particularly the water pump impeller and cylinder liners.

Cavitation in an engine can be caused by:

- Improper coolant
- Restricted coolant flow caused by collapsed hose or plugged system
- Coolant fill cap is loose or unable to retain the required pressure
- Insufficient fluid level
- Failure to de-aerate
- Overheat

3.5 ELECTRICAL SYSTEM

3.5.1 Wiring Diagrams (Only with Engine Gauge Panel)

Run/Stop Solenoid	Drawing No.	Description (DC Voltage)	Reference Document
ETR	C07575 (JU4/6)	Mechanical Engines NFPA-20 and UL/FM engine gauge panel (NL Models - Optional)	(Mechanical Engines)
ETR	C071360	Electronic Engine NFPA20 and UL/FM engine gauge panel	JU Electronic Engines
		NFPA-20 and UL/FM	JW Electronic Engines

ETR	C07602 (JW6)	engine gauge panel (NL Models - Optional)	(Mechanical Engines)
ETS	U071056	LPCB Engine Gauge Panel	(Mechanical Engines)
ETR	C071612	UL/FM Front Opening Instrument Panel	(Mechanical Engines)
ETR/ETS	C071590	UL/FM Front Opening Instrument Panel with C071571/ C071963 speed switch	
ETR	C071299	UL/FM Front Opening Instrument Panel with C071571/ C071963 speed and emergency bypass switch	

ETR = Energized to Run

Drawing No.	Description (AC Voltage)
C07651 (JU4/6, JW, JX)	NFPA-20, UL/FM, and LPCB Engine Jacket Water Heater (NL Models - Optional)
C07651 (JDFP/JW6)	Optional Engine Jacket Water Heater (NL Models - Optional)

Figure #36

3.5.2 Checking Drive Belt Tension and Adjustment

All drive belts must be adequately tightened to secure that both the engine water pump and battery charging alternator (when fitted) are operating efficiently. Refer to *Figure #37*.

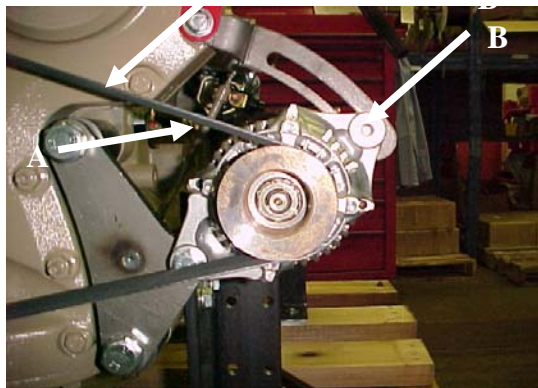

Figure #37

To adjust Belt Tension:

Check belt tension:

- Give at arrow must be .4" - .6" (10-15mm).

To increase tension of the water pump driving belts:

- Loosen alternator or belt tensioner mounting bolts A and B.
- Adjust to proper belt tension.
- Tighten mounting bolts A and B.

3.5.3 Speed Switch (when supplied)

Overspeed is defined as 120% of rated speed for engines rated from 1470 through 2600 rpm, and 110% of rated speed for engines rated from 2800 through 3000 rpm. In the event of an engine overspeed, the speed switch signals the main pump controller and also affects an engine shutdown. A visual overspeed warning lamp will illuminate on the Clarke panel (*figure #37A*). The OVERSPEED RESET (*figure# 9*) switch is included on the instrument panel. Should an overspeed condition occur, investigate the cause and make necessary corrections before placing engine back in service. The OVERSPEED RESET must be manually lifted to reset.

NOTE: This reset operation must be completed to allow a restart. If not, the engine will not start thru the main pump controller or manually.

OVERSPEED VERIFICATION

Hold the OVERSPEED VERIFICATION switch in the "up" position. This will provide the main pump controller with an overspeed signal and engine shutdown at 67% of the set overspeed RPM.

Start the engine via the main pump controller; the speed switch will generate an overspeed signal and shutdown protecting both the engine and pump.

EXAMPLE

Rated Speed: 1760 RPM

Overspeed Shutdown: 2112 RPM (120% of 1760 RPM)

Verification Shutdown: 1410 RPM (67% of 2112 RPM)

CAUTION-after verification of overspeed, lift the OVERSPEED RESET switch and reset the main pump controller to re-instate normal operation of the engine and speed switch.

Refer to Engineering Technical Bulletin – ETB003, part number C133407, on the www.clarkefire.com website for adjusting the overspeed setting for range rated engines.

3.5.4 Magnetic Pick-Up (when supplied)

A magnetic pick-up, mounted in the flywheel housing, provides the input signal for the tachometer overspeed switch, and/or the main pump controller. There should be a 0.03" air gap between the top of the ring gear and the center of the magnetic pick-up. With one tooth centered in the magnetic pick-up hole, thread the pickup in until it touches the gear tooth and then back it out 1/2 turn. Tighten jam nut while holding the pickup in position. Reconnect to wiring harness.

3.5.5 Mechanical Engine Control and Alarm Board (MECAB) Speed Switch Troubleshooting

This engine may be equipped with a speed switch p/n C071571 capable of sensing engine sensor malfunctions and/or electrical over-current(s) on engine alarm circuits and alerting the user via flashing status lamps. This flashing status indication is done so with the red "OVERSPEED SHUTDOWN" lamp on the outside of the Clarke instrument panel (Figure #37A) and a red LED located on the middle of the speed switch inside of

the Clarke instrument panel (Figure #37B). In addition to these flashing status lamps, a “Low Engine Coolant Temperature Alarm” is sent via engine / fire pump controller inter-connect circuit #312 as a means to alert the user outside of the engine room.

Note: When first applying battery power to the engine, or after activating the overspeed reset switch, the OVERSPEED SHUTDOWN lamp and red LED on the speed switch will flash several times. This is an “INITIALIZATION PATTERN” and is normal. This will be referred to in the following troubleshooting section.

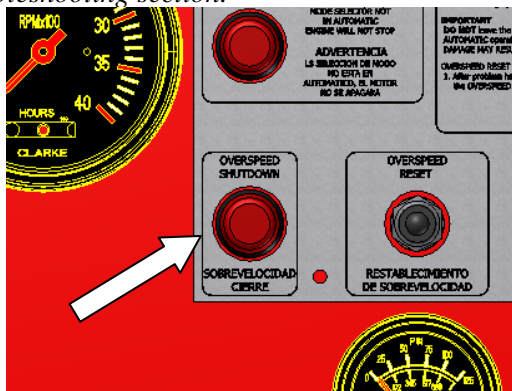

Figure #37A

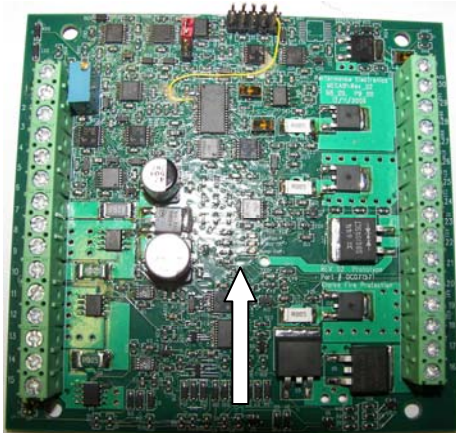

Figure #37B

List of Troubleshooting Malfunctions

Two (2) blinks – Electrical Current Exceeds 10 Amps on Alarm Circuits: Status lamps will flash two times continuously on the Clarke instrument panel and a “Low Engine Coolant Temperature” alarm will be sent to the fire pump controller via circuit #312.

Cause:

Electrical current exceeds 10 amps on one or more engine / fire pump controller inter-connect circuits

- Engine run alarm (#2)
- Engine overspeed alarm (#3)
- Engine low oil pressure alarm (#4)
- Engine high coolant temperature alarm (#5)
- Engine low coolant temperature alarm (#312)

Corrective actions:

Check each of the above circuits to determine which contains the current overload.

Once circuit(s) overload are corrected: On the Clarke instrument panel, operate the “OVERSPEED RESET” switch for two (2) seconds and release (Figure #37C).

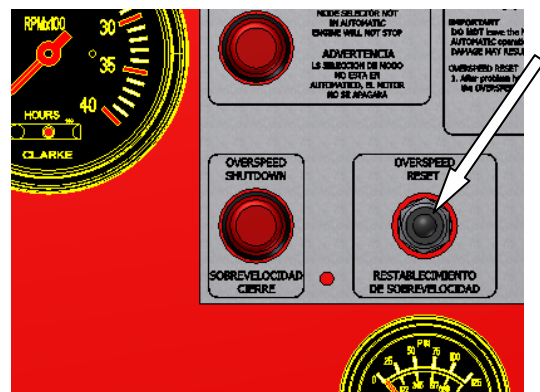

Figure #37C

The “INITIALIZATION PATTERN” will flash. This is normal. The continuous two (2) blink flash sequence should turn off at this point.

Three (3) blinks – Engine Coolant Temperature Sensor malfunction: Status lamps will flash three times continuously on the Clarke instrument panel and a “Low Engine Coolant Temperature” alarm will be sent to the fire pump controller via circuit #312.

Cause:

Engine coolant temperature sensor circuit is open or closed

Corrective Actions:

Verify wiring and connector plug at engine coolant temperature sensor are secure. Sensor is located behind engine thermostat housing.

On the Clarke instrument panel, operate the “OVERSPEED RESET” switch for two (2) seconds and release. (Refer to *Figure #37C*).

The “*INITIALIZATION PATTERN*” will flash. This is normal. The continuous three (3) blink flash sequence should turn off at this point.

If problem still exists, replace engine coolant temperature sensor, Clarke part number C071607

Five (5) blinks on instrument panel – Oil pressure switch or Engine speed sensor (magnetic pick-up) malfunction:

Status lamps will flash five times continuously on the Clarke instrument panel and a “Low Engine Coolant Temperature” alarm will be sent to the fire pump controller via circuit #312.

Cause:

Oil pressure switch failure or magnetic pick-up failure.

Corrective Actions:

Oil Pressure switch check

Verify wiring and connector at engine oil pressure switch are secure. Pressure switch is located on left side of engine (JU models) and right side of engine (JW models)

With engine off, check continuity between the two terminals on the oil pressure switch. Note, do not disconnect wires when performing this task.

If circuit is open, replace oil pressure switch, Clarke part number C072011.

After new switch is replaced: On the Clarke instrument panel, operate the “OVERSPEED RESET” switch for two (2) seconds and release. (Refer to *Figure #37C*)

The “*INITIALIZATION PATTERN*” will flash. This is normal. The continuous five (5) blink flash sequence should turn off at this point.

If circuit is closed, the oil pressure switch is not damaged and is working normally as expected. Proceed to engine speed sensor check, below.
Engine speed sensor (magnetic pick-up) check
Verify wiring and connector at engine speed sensor are secure. Magnetic pick-up is located on top of the flywheel housing.

With engine running, verify that the tachometer is functioning normally.

Refer to section 3.5.4 of Engine Operator’s Manual to properly reposition the magnetic pick-up if tachometer is not functioning.

Once magnetic pick-up is repositioned: On the Clarke instrument panel, operate the “OVERSPEED RESET” switch for two (2) seconds and release. (Refer to *Figure #37C*).

“OVERSPEED SHUTDOWN” lamp will flash a sequence of one (1) blink, then four (4) blinks. This is normal. The continuous five (5) blink flash sequence should turn off at this point. If problem still exists, replace engine speed sensor (magnetic pick-up), Clarke part number C071883.

3.5.6 FIELD SIMULATION OF PUMP CONTROLLER ALARMS

Field simulation of (5) pump controller alarms

- Alarm 1: Over speed Shutdown: Follow over speed verification steps per section 3.5.3.

- Alarm 2: Low Oil Pressure: With the engine running, jumper across two outer terminals with wires attached to the engine mounted Low Oil Pressure switch.

Wait for 15 seconds and controller alarm will activate.

- Alarm 3: High Engine Coolant Temperature: With the engine running, set the High Engine Coolant Temperature DIP switch to “ON” (see *Figure #37D*). Use a fine pick or small screwdriver and slide the white slider to the left. Wait for 30 seconds and controller alarm will activate. Set white DIP switch slider to “OFF” (right) when simulation is complete.

- Alarm 4: Low Engine Coolant Temperature: With the engine not running, set the Low Engine Coolant Temperature DIP switch to “ON” (see *Figure #37D*). Use a fine pick or small screwdriver and slide the white slider to the right. Controller alarm will activate immediately. Set white DIP switch slider to “OFF” (left) when simulation is complete.

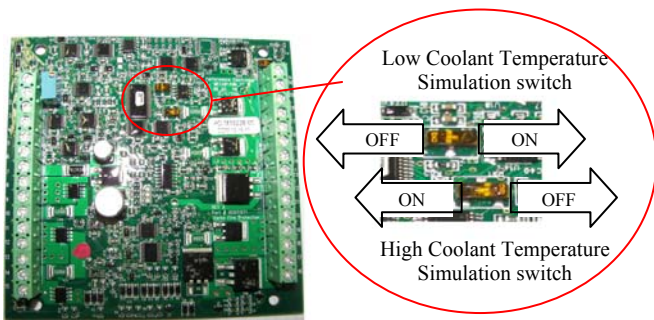

Figure #37D

• Alarm 5: Overcrank: **NEVER** shut off the fuel supply to the engine to prevent it from starting. Shutting off the fuel supply will cause an air lock condition in the fuel system and possibly cause fuel system component damage.

ETR Governor Solenoid: Activate and hold the Overspeed Reset switch while performing the overcrank test. Switch must be held continuously each time the engine attempts a crank start. This will allow the engine to crank only but will prevent it from running.

ETS Governor Solenoid: Use manual stop override to prevent the engine from starting during the cycle-crank testing. Override must be held continuously each time the engine attempts a crank start. This will allow the engine to crank only but will prevent it from running.

3.5.7 BATTERY REQUIREMENTS

All Clarke engine models require 8D batteries, as sized per SAE J537 and NFPA20. The battery should meet the following criteria:

- Cold Cranking Amps (CCA @ 0°F): 1400
- Reserve Capacity (minutes): 430

Refer to Clarke drawing C131885 (see Page 5) for additional information on Clarke supplied batteries.

3.6 ENGINE SPEED ADJUSTMENT

A mechanical governor controls the engine speed. The governor is built into the fuel injection pump. All governors are adjusted to the rated speed at nameplate power or maximum allowed pump load before leaving Clarke. During Start-Up Inspection or when placing reconditioned units into service, some minor speed adjustment may be required. It is

recommended that this adjustment be performed by the authorized Service Dealer representative.

To adjust the speed of the engine:

- A. Start the engine by following the “To Start Engine” Procedure in this manual.
- B. Let the engine warm-up. Loosen the jam nut(s) (Figure #38).
- C. While observing the instrument panel tach rotate the long adjustor clockwise to lower the RPM and counter clockwise to raise the RPM’s until desired speed is obtained. Ref. Figure #38A.
- D. Holding secure the long adjustor with a wrench tighten the jam nut.
- E. Stop engine by following “To Stop Engine” Procedure in this manual.

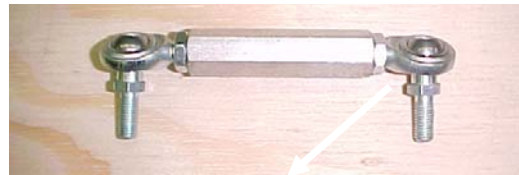

Figure #38A

If the engine has been designed and tested for range rating, stamp the metal tag titled “FIELD SETTING” with the final adjusted speed, horsepower, and overspeed shutdown setting and keep with the engine. Refer to Figure #38B.

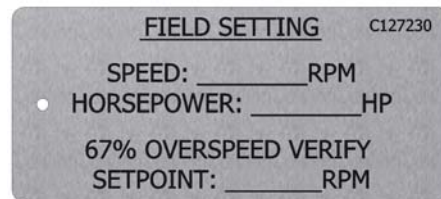

Figure #38B

4.0 MAINTENANCE SCHEDULE

4.1 ROUTINE MAINTENANCE

NOTE: The following Routine Maintenance schedule is based on an engine usage rate not exceeding 2 hours per month. For UL/FM engine models, also refer to NFPA25.

LEGEND:

- ☐ Check
- ❖ Clean
- Replace
- Lubricate

WEEKLY

- ☐ Air Cleaner
- ☐ Battery
- ☐ Belts
- ☐ Coolant Hoses

- Coolant Leaks
- Coolant Levels and Condition
- Cooling Loop Valves Position
- Cooling Water Solenoid Valve
- Cooling Water Discharge
- Exhaust System
- Fuel Tank
- General Inspection
- Governor Run-Stop Control
- Jacket Water Heater
- Lubrication Oil Level
- Operating Gauges
- Remove Water from Fuel Filter
- Run Engine
- Warning Light
- ❖ Cooling Water Strainers
- ❖ Clean Radiator Core Debris (if equipped)

EVERY 6 MONTHS

- ❖ Batteries
- Battery Charging Alternator
- Belt tension
- Coolant Protection Level
- Driveshaft U-Joints
- Fuel Lines

EVERY 1 YEAR

- ❖ Air Cleaner
- Coolant Inhibitor
- Crankcase Vent System
- Driveshaft U-Joints
 - Fuel & Oil Filters
 - Heat Exchanger Electrode
 - Lubricating Oil
 - Mounting Isolators
 - Wiring System

EVERY 2 YEARS

- Air Cleaner
- Batteries
- Belts
- Coolant Hoses
- Coolant
- Thermostat
- Remove Water Pump to Inspect Impeller and Seal

IMPORTANT: Set main pump controller to “OFF” while servicing engine. Before turning the main pump controller to the "OFF" position, check with the maintenance and security supervisors to verify that all the departments concerned will be alerted of the temporary interruption of their fire protection equipment for normal maintenance or testing. Also, alert the local fire department in the event that the main pump controller is connected by silent alarm to

headquarters. When servicing is complete, return main pump controller selector to "Automatic" position and the mode selector on the engine to “Automatic” position. Advise the appropriate personnel the engine has been returned to the “Automatic”.

5.0 TROUBLE SHOOTING

Consult Clarke Service Dealer or Factory. Service dealers can be located by going to our website: www.clarkefire.com.

6.0 PARTS INFORMATION

6.1 SPARE PARTS

To ensure best operation and efficiency of all engine components, always use genuine Clarke spare parts.

Orders should specify:

- Engine Model Number - See Engine General
- Engine Serial Number - Specification
- Part Number(s) Refer to Engine Maintenance Parts List section 6.2 or Parts Illustration (see Page 5).

Contact numbers for spare parts:

- www.clarkefire.com
- Phone USA: (513) 771-2200 Ext. 427 (calling within USA)
- Phone UK: (44) 1236 429946 (calling outside USA)
- Fax USA: (513) 771-5375 (calling within USA)
- Fax UK: (44) 1236 427274 (calling outside USA)
- E-Mail USA: parts@clarkefire.com
- E-Mail UK: dmurray@clarkefire.com

6.2 ENGINE MAINTENANCE PARTS LIST

Refer to Appendix “A” at the end of this manual.

ENGINE MODEL	Air Filter Service Kit	Air Filter Oil
All	99-55050	C121157

Figure #39

7.0 OWNER ASSISTANCE

Consult Clarke Service Dealer or Factory. Service Dealers can be located by going to our website: www.clarkefire.com.

8.0 WARRANTY

8.1 GENERAL WARRANTY STATEMENT

The satisfactory performance of Clarke engines and the goodwill of owners / operators of Clarke engines are of primary concern to the Engine Manufacturer, the Engine Service Dealer and Clarke. All provide support of these products after final installation of the complete fire pump and sprinkler system.

Warranty responsibility involves both Clarke and the John Deere service organizations worldwide.

The Engine Manufacturer (John Deere) provides Warranty for the basic engine components and Clarke provides warranty on the accessories added to meet the NFPA-20 specifications and FM/UL certification requirements.

8.2 CLARKE WARRANTY

All Clarke warranted components have warranty for a duration of 24 months beginning at the Start-up date of the fire pump system. The warranty coverage includes replacement of the part and reasonable cost of labor for installation. Components failed due to improper engine installation, transportation damage, or misuse is not covered under this warranty.

For additional warranty details, see the specific warranty statement “John Deere New Engine Warranty” on the following page. Also contact Clarke direct if you have any questions or require additional information.

Clarke is not responsible for incidental or consequential costs, damage or expenses which the owner may incur as a result of a malfunction or failure covered by this warranty.

8.3 JOHN DEERE WARRANTY

8.3.1 Warranty Duration

Unless otherwise provided in writing, John Deere* makes the following warranty to the first retail purchaser and each subsequent purchaser (if purchase is made prior to expiration of applicable warranty) of each John Deere new off-highway engine marketed as part of a product manufactured by a company other than John Deere or its affiliates:

- 12 months, unlimited hours of use, or
- 24 months and prior to the accumulation of 2000 hours of use; and on each John Deere engine used in an off-highway repower application:
- 12 months, unlimited hours of use.

Note: In the absence of a functional hourmeter, hours of use will be determined on the basis of 12 hours of use per calendar day. (*John Deere” means Deere Power Systems Group with respect to users in the United States, John Deere Limited with respect to users in Canada, and Deere & Company or its subsidiary responsible for marketing John Deere equipment in other countries where the user is located)

8.3.2 Warranty Coverage

This warranty applies to the engine and to integral components and accessories sold by John Deere.

All John Deere-warranted parts and components of John Deere engines which, as delivered to the purchaser, are defective in materials and/or workmanship will be repaired or replaced, as John Deere elects, without charge for parts or engine repair labor, including reasonable costs of labor to remove and reinstall non engine parts or components of the equipment in which the engine is installed, and, when required, reasonable costs of labor for engine removal and reinstallation, if such defect appears within the warranty period as measured from the date of delivery to the first retail purchaser, if the delivery is reported to John Deere within 30 days of the delivery.

8.3.3 Emissions System Warranty (Non-Road Diesel)

EMISSIONS CONTROL SYSTEM CERTIFICATION LABEL

WARNING: Statutes providing severe penalties for tampering with emissions controls may apply at the user’s location.

The emissions warranty described below applies only to those engines marketed by John Deere that have been certified by the United States Environmental Protection Agency (EPA) and/or California Air Resources Board (CARB); and used in the United States in equipment. The presence of an emissions label like the one shown signifies that the engine has been certified with the EPA and/or CARB. The EPA and CARB warranties only apply to new engines having the certification label affixed to the engine and sold as stated above in the geographic areas governed by the regulation agencies.

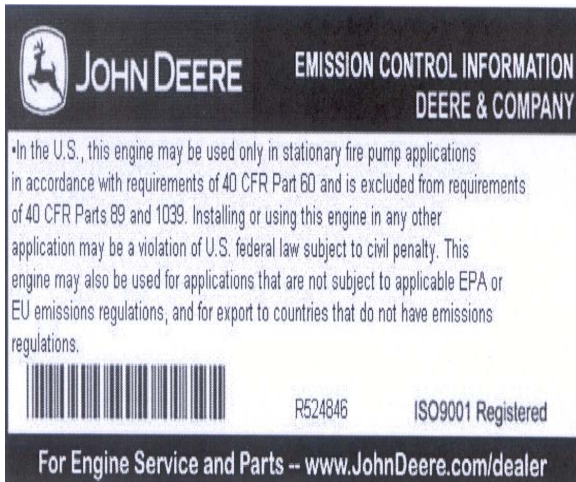

Note: The hp/kW rating on the engine emissions certification label specifies the gross engine hp/kW, which is flywheel power without fan. In most applications this will not be the same rating as the advertised vehicle hp/kW rating.

Stationary engines under the NSPS provisions are also covered, including stationary fire pump ratings. Fire pump ratings labeled under the 40 CFR part 60 (NSPS).

U.S. EMISSIONS CONTROL WARRANTY STATEMENT (UNITED STATES ONLY)

Emissions control-related parts and components are warranted by John Deere for five years or 3000 hours of operation, whichever occurs first. John Deere further warrants that the engine covered by this warranty was designed, built, and equipped so as to conform at the time of sale with all U.S. emissions standards at the time of manufacture, and that it is free of defects in materials and workmanship which would cause it not to meet these standards within the period of five years or 3000 hours of operation, whichever occurs first.

Warranties stated in this manual refer only to emissions-related parts and components of your engine. For complete engine warranty, less emissions related parts and components, ref to 8.3.1.

COVERED EMISSIONS SYSTEMS AND COMPONENTS

System	Sample Sub-Systems and Components
Air induction system	<ul style="list-style-type: none"> ○ Air filter housing ○ Air mass sensor assembly ○ Controlled hot air intake system ○ Heat riser ○ Intake manifold

	<ul style="list-style-type: none"> ○ Intercooler ○ Turbocharger ○ Wastegate control assembly valve
Fuel metering system (fuel system)	<ul style="list-style-type: none"> ○ Aneroid ○ Carburetor ○ Choke mechanism ○ Electronic injection unit ○ Fuel injection assembly ○ Fuel injection nozzle assembly ○ Fuel injection injector ○ Fuel injector nozzle ○ Fuel injection valve assembly ○ Fuel line ○ Gas pressure regulator ○ Pressure relief valve/assembly ○ Air restriction sensor ○ Air temperature sensor ○ Coolant temperature sensor ○ Fuel temperature sensor ○ Mass flow module sensor ○ UEGO sensor ○ Throttle
Ignition control system	<ul style="list-style-type: none"> ○ Distributor assembly ○ Engine control module ○ Glow plugs ○ Ignition coil ○ Ignition control module ○ Ignition sensor ○ Ignition wires ○ Spark plugs
EGR system	<ul style="list-style-type: none"> ○ EGR cooler ○ EGR valve body
Advanced Oxides of Nitrogen (NOx controls)	<ul style="list-style-type: none"> ○ Lean NOx catalysts ○ Nox absorbers ○ Reductant (urea/fuel) containers/dispensing systems
Catalyst or thermal reactor system	<ul style="list-style-type: none"> ○ Catalytic converter ○ Double wall portion of exhaust system ○ Exhaust manifold ○ Exhaust gas recirculation valve
Particulate Controls	<ul style="list-style-type: none"> ○ Control device enclosure and manifolding ○ Regenerators ○ Oxidizers ○ Traps ○ Filters ○ Precipitators ○ Manifold absolute pressure (MAP) sensor
PCV system	<ul style="list-style-type: none"> ○ Oil filler cap ○ PCV solenoid ○ PCV valve ○ Crankcase ventilation filter ○ Crankcase ventilation valve
Miscellaneous items used in the above systems	<ul style="list-style-type: none"> ○ Electronic control sensors ○ Electronic control units (ECUs) ○ ECU software ○ Pump/valve controllers ○ Wiring harness ○ Coolant temperature sensor ○ Emissions labels ○ Sealing gaskets

	<ul style="list-style-type: none"> ○ Thermocouples ○ Thermostats ○ Vacuum-sensitive valve/switches
--	---

8.3.4 Obtaining Warranty Service

Warranty service must be requested of the nearest authorized John Deere engine service outlet before the expiration of the warranty. An authorized service outlet is a John Deere engine distributor, a John Deere engine service dealer, or a John Deere equipment dealer selling and servicing equipment with an engine of the type covered by this warranty.

Authorized service outlets will use only new or remanufactured parts or components furnished or approved by John Deere.

Authorized service locations and the name of the John Deere division or subsidiary making this warranty are listed in the Parts and Service Directory for John Deere Engines.

At the time of requesting warranty service, the purchaser must be prepared to present evidence of the date of delivery of the engine.

John Deere reimburses authorized service outlets for limited travel expenses incurred in making warranty service repairs in non-John Deere applications when travel is actually performed. The limit, as of the date of publication of this statement, is US \$300.00 or equivalent. If distances and travel times are greater than reimbursed by John Deere, the service outlet may charge the purchaser for the difference.

8.3.5 Warranty Exclusions

John Deere's obligations shall not apply to fuel injection pump and nozzles during the pump and nozzle manufacturer's warranty period on the pump and nozzles, components and accessories which are not furnished or installed by John Deere, nor to failures caused by such items. When the pump manufacturer's warranty is less than the engine warranty, John Deere will reimburse pump repair costs for warrantable-type failures during the remainder of the original engine warranty period, when so documented by the pump manufacturer's approved service outlet.

8.3.6 Purchaser's Responsibilities

The cost of normal maintenance and depreciation.

Consequences of negligence, misuse, or accident involving the engine, or improper application,

installation, or storage of the engine, or improper application, installation, or storage of the engine.

Consequences of service performed by someone other than a party authorized to perform warranty service, if such service, in John Deere's judgment, has adversely affected the performance or reliability of the engine.

Consequences of any modification or alteration of the engine not approved by John Deere, including, but not limited to, tampering with fuel and air delivery systems.

The effects of cooling system neglect as manifested in cylinder liner or block cavitation ("pitting", "erosion", "electrolysis").

Any premium for overtime labor requested by the purchaser.

Costs of transporting the engine or the equipment in which it is installed to and from the location at which the warranty service is performed, if such costs are in excess of the maximum amount payable to the service location were the warranty service performed at the engine's location.

Costs incurred in gaining access to the engine; i.e., overcoming physical barriers such as walls, fences, floors, decks or similar structures impeding access to the engine, rental of cranes or similar, or construction of ramps or lifts or protective structures for engine removal and reinstallation.

Incidental travel costs including tolls, meals, lodging, and similar.

Service outlet costs incurred in solving or attempting to solve non-warrantable problems.

Services performed by a party other than an authorized John Deere engine service dealer, unless required by law.

Charges by dealers for initial engine start-up and inspection, deemed unnecessary by John Deere when operation and maintenance instructions supplied with the engine are followed.

Costs of interpreting or translating services.

8.3.7 No Representations or Implied Warranty

Where permitted by law, neither John Deere nor any company affiliated with it makes any guaranties, warranties, conditions, representations or promises, express or implied, oral or written, as to the nonoccurrence of any defect or the quality or

performance of its engines other than those set forth herein, and DOES NOT MAKE ANY IMPLIED WARRANTY OR CONDITIONS OF MERCHANTABILITY OR FITNESS otherwise provided for in the Uniform Commercial Code or required by any Sale of Goods Act or any other statute. This exclusion includes fundamental terms. In no event will a John Deere engine distributor or engine service dealer, John Deere equipment dealer, or John Deere or any company affiliated with John Deere be liable for incidental or consequential damages or injuries including, but not limited to, loss of profits, loss of crops, rental of substitute equipment or other commercial loss, damage to the equipment in which the engine is installed or for damage suffered by purchaser as a result of fundamental breaches of contract or breach of fundamental terms, unless such damages or injuries are caused by the gross negligence or intentional acts of the foregoing parties.

8.3.8 Remedy Limitation

The remedies set forth in this warranty are the purchaser's exclusive remedies in connection with the performance of, or any breach of guaranty, condition, or warranty in respect of new John Deere engines. In the event the above warranty fails to correct purchaser's performance problems caused by defects in workmanship and/or materials, purchaser's exclusive remedy shall be limited to payment by John Deere of actual damages in an amount not to exceed the cost of the engine.

8.3.9 No Seller's Warranty

No person or entity, other than John Deere, who sells the engine or product in which the engine has been installed makes any guaranty or warranty of its own on any engine warranted by John Deere unless it delivers to the purchaser a separate written guaranty certificate specifically guaranteeing the engine, in which case John Deere shall have no obligation to the purchaser. Neither original equipment manufacturers, engine or equipment distributors, engine or equipment dealers, nor any other person or entity, has any authority to make any representation or promise on behalf of John Deere or to modify the terms or limitations of this warranty in any way.

8.3.10 Additional Information

For additional information concerning the John Deere New Off-Highway Engine Warranty, see booklet Engine Owner's Warranty – Worldwide.

9.0 ATCM CALIFORNIA EMISSIONS REGULATIONS FOR STATIONARY ENGINES

NOTICE AND DISCLAIMER FOR STATIONARY COMPRESSION IGNITION ENGINES INSTALLED IN CALIFORNIA AFTER JANUARY 1, 2005

1. This Notice and Disclaimer is an addendum to, and made a part of, Clarke's Fire Protection Products, Inc.'s ("Clarke") Standard Terms and Conditions of Sale and, in all respects not inconsistent therewith, also applies to all sales of stationary compression ignition engines installed in California after January 1, 2005.
2. Stationary diesel-fueled compression ignition engines installed in California after January 1, 2005 are subject to California's Airborne Toxic Control Measure for Stationary Compression Ignition Engines (the "ATCM"), Cal. Code Regs. Title 17, Section 93115. The California Air Resources Board ("CARB") has reviewed the emissions estimation methodology provided by Clarke Fire Protection Products, Inc. ("Clarke") and has concluded that Clarke has used a valid methodology for estimating the emissions from engines supplied by Clarke and that the engines presumptively comply with the ATCM's emissions standards. Clarke's methodology used existing emissions test data associated with similar engines to estimate the emissions produced by the emergency fire pump engines supplied by Clarke.
3. CARB's determination is not binding on the local air districts, which have primary jurisdiction for implementing and enforcing the ATCM. Actual test data in the field or other information established by the local air districts or CARB that show actual emissions from an engine supplied by Clarke in excess of the ATCM limitations could indicate a violation of the ATCM and subject the seller, owner and operator of the engine to penalties

under California law. Although Clarke believes that the engines supplied by Clarke comply with the ATCM based on the available data and methodology accepted by CARB, for the foregoing reasons, Clarke cannot, and does not, guarantee that its engines will comply with the ATCM emission regulations.

4. CLARKE MAKES NO WARRANTIES OR GUARANTIES, EXPRESS OR IMPLIED, INCLUDING ANY WARRANTY OF MERCHANTABILITY, FITNESS FOR A PARTICULAR PURPOSE OR OTHERWISE, THAT THE ENGINES SUPPLIED BY CLARKE WILL COMPLY WITH THE ATCM. CLARKE ALSO EXPRESSLY DISCLAIMS THAT THE ENGINES SUPPLIED BY CLARKE WILL, IN FACT, COMPLY WITH THE ATCM. IN NO EVENT SHALL CLARKE BE LIABLE FOR SPECIAL, INCIDENTAL OR CONSEQUENTIAL DAMAGES ARISING OUT OF OR IN CONNECTION WITH THESE TERMS AND CONDITIONS OR THE ENGINES SUPPLIED BY CLARKE OR FOR INDEMNIFICATION OF BUYER ON ACCOUNT OF ANY CLAIM ASSERTED AGAINST BUYER, OR FOR ANY OTHER DAMAGE OF ANY KIND, WHETHER DIRECT OR INDIRECT, IF THE ENGINES SUPPLIED BY CLARKE DO NOT COMPLY WITH THE ATCM.
5. If Buyer resells any of the goods sold under this Agreement, Buyer shall include language in an enforceable agreement with its buyer that makes the language in this Agreement, including Clarke's disclaimer of warranties and remedies in paragraph 5, binding on its buyer. Buyer shall defend, indemnify and hold Clarke harmless from any claims, causes of action, damages, losses or expenses (including reasonable attorney's fees) that Clarke incurs by reason of Buyer's failure to comply with this paragraph.
6. Each Clarke ATCM Compliant Fire Pump Driver will be affixed with the following ATCM Tier 2 Label:

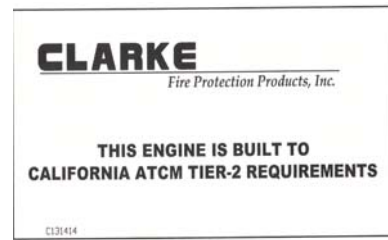

7. Each Clarke ATCM Compliant Fire Pump Driver will be stamped with new fuel injection pump timing alignment marks. Refer to figure #___. Original 'factory' timing marks will be "X" out.

10.0 INSTALLATION & OPERATION DATA
(See clarkefire.com)

11.0 WIRING DIAGRAMS
(See clarkefire.com)

12.0 PARTS ILLUSTRATION DRAWING
(See clarkefire.com)

13.0 APPENDIX (Alpha Index)

Subject	Page
A	
ATCM Compliant Engines.....	47,48
Air Cleaner.....	27,42
Alternator.....	38,39,43
B	
Battery Cables.....	14,17,18
Battery Recommendations.....	14, 41
Belt Adjustment.....	14,38,42
C	
Capacities.....	31,32
Coolant Recommendations.....	31,32
Cooling System	
Anti-Freeze Solutions.....	31
Cooling System Capacity.....	32
Cooling Water Supply (Loop).....	13,18,34,35, 36
Cooling Water Flow Requirements.....	*
Filling Procedure.....	32
Heat Exchanger.....	10,11,13,18,19, 31, 33,34,35,36,37,43
Inhibitors.....	31,32,43
Maintenance.....	12,13,14,18, 31,32,34,42
Radiator.....	11,12,13,18,27, 31,34,36,37,43
Water.....	31
Crankcase Ventilation.....	28,43
D	
Dipstick, Oil Level.....	29
Driveshaft alignment.....	14
Driveshaft Maintenance.....	18,42
E	
Electrical System.....	38
Engine Models.....	5,6
Engine Protective Systems (overspeed).....	19,20,39
Engine Start-Up Service.....	18
Exhaust System.....	27,29
F	
Filters:	
Air Cleaner.....	27,42
Fuel.....	12,13,21,22,23, 24,25
Lubricating Oil.....	12,30,43
Fuel Specifications.....	12,13
Fuel System Operation.....	21
Bleeding.....	21
Pump, Injection.....	5,21,22,25,26, 42,46,48
Pump, Lift.....	21,22
Service.....	21 to 25
G	
Governor Speed Adjustment.....	42

Subject	Page
H	
Heaters, Engine.....	11,13,14,31,36, 37,38,42
I	
Installation Data.....	*
Installation Instructions.....	12
L	
Lube Oil Recommendations.....	30,31
Lubricating Oil Volume.....	31
Lubricating System.....	29
M	
Magnetic Pickup.....	39
Maintenance Schedule.....	42
Manual Operation.....	18
Model Number Identification.....	5
N	
Name Plate (Engine).....	5,6
O	
Oil Filter.....	12,30,43
Oil Level Dipstick.....	29
Oil Pressure.....	*
Oil Specifications/Recommendations.....	30,31
Operation Data.....	*
Overspeed Reset.....	19,20,39
Overspeed Verification.....	39
P	
Parts Illustrations.....	*
Parts Information.....	43
Preventive Maintenance Schedule.....	42
S	
Serial Number.....	5,6,9
Shutdown Systems.....	21,39,40
Speed Switch.....	39
Storage.....	12
T	
Technical Data.....	*
W	
Warranty.....	43
Wiring Diagram:	
DC System.....	14,38*
AC Heater Systems.....	38*

* See clarkefire.com

Appendix "A"

JU4H AND JU4R MODELS

Clarke Engine Models	UF10, 12, 20, 22, AB26 JU4R-09, 11, 19, 21	UF14, 24 JU4R- UF13, 23	UF28, 30, 32, 40, 42, 50, 52, 58, H0, H2, H8 JU4R- UF40, 49, 51	UF34, UF44, 54 JU4R- UF53	UF84	UFAEA0, E8,F2 JU4R- UFAEA9, E7, F1	UFADHG, J8, J2
Part Description	Part Number (standard items only, optional items not shown)						
Oil Filter	C04440	C04521	C04440	C04521		C04616	
Fuel Filter (Primary)	C02359	C02549	C02359	C02549		C02883	
Fuel Filter (Secondary)	N/A						
Air Filter	C03249						
Alternator	C071047 (12V) or C071048 (24V)						
Fuel Injection Pump	C02896	C02897	C02898	C02899	C02900	C02901	
Heat Exchanger	C051128 (USA built) or C051001 (UK built)						
Starter Motor (12V)	RIGHT SIDE-C07888 AND LEFT SIDE-C07889 or RIGHT SIDE C071071 AND LEFT SIDE-C071072						
Starter Motor (24V)	RIGHT SIDE-C071073 AND LEFT SIDE C071074						
Switch, Oil Pressure	C071273 OR C071884						
Switch, Speed	C071001 OR C071571						
Switch, Coolant Temperature	C125678 OR C071881						
Turbocharger	N/A		C061634 OR C061635	C061636	C061637	C061638	
Thermostat	C052057	C051275	C052057	C051275	C052057		
Nozzle, Injector	C02360					C02925	

JU6H AND JU6R MODELS

Clarke Engine Models	UF30, UF32,	UF50, UF58, UFD0, UFG8, UFM0, UFM8, UFABL8, UFABL0, UFABL2,	UF52, UFD2, UFM2,	UF60, UF68,	UF62,	UF34, UF54, UFAB54,	UF84, UFAB76, UFAB84,	UFAAQ8, UFKAQ8, UFAARG, UFKARG, UFAAPG, UFKAPG, UFAAS0, UFKAS0,
	JU6R- UFAA29, UFKA29, UFAA31, UFKA31	JU6R- UFAA49, UFKA49, UFAA57, UFKA57, UFAAD9, UFKAD9, UFAAG7, UFKAG7, UFAAL7, UFKAL7, UFAAL9, UFKAL9, UFAAL1, UFKAL1, UFAAM7, UFKAM7, UFAAM9, UFKAM9	JU6R- UFAA51, UFKA51, UFAAD1, UFKAD1, UFAAM1, UFKAM1	JU6R- UFAA59, UFKA59, UFAA67, UFKA67	JU6R- UFAA61, UFKA61	JU6R- UFAA33, UFKA33, UFAA53, UFKA53	JU6R- UFAA83, UFKA83	JU6R- UFAA59, UFAAPF, UFKAPF, UFAAQ7, UFKAQ7, UFAARF, UFKARF, UFKAS9
Part Description	Part Number (standard items only, optional items not shown)							
Oil Filter	C04440				C04521		C04440	
Fuel Filter (Primary)	C02359				C02550		C02359	
Fuel Filter (Secondary)	N/A							
Air Filter	C03396							
Alternator	C071047 (12V) or C071048 (24V) OR C071517							
Fuel Injection Pump	C02902 or C02903			C02904	C02905	0C2906	C02907	
Heat Exchanger	C051127 (USA built) or C051002 (UK built)							
Starter Motor (12V)	RIGHT SIDE-C07888 AND LEFT SIDE-C07889 or RIGHT SIDE C071071 AND LEFT SIDE-C071072							
Starter Motor (24V)	RIGHT SIDE-C071073 AND LEFT SIDE C071074							
Switch, Oil Pressure	C071273 OR C071884 OR C072011 OR C072013							
Switch, Speed	C071001							
Switch, Coolant Temperature	C125678 OR C071881							
Turbocharger	C061639 or C061640				C061641		C061642	
Thermostat	C052057				C051275		C052057	
Nozzle, Injector	C02360							

JW6H MODELS

Clarke Engine Models	UF30, UF38	UF40, UF48	UFH8, UF50, UF58, UF60
Part Description	Part Number (standard items only, optional items not shown)		
Oil Filter	C04614		
Fuel Filter (Primary)	C02881		
Fuel Filter (Secondary)	C02882		
Air Filter	C03244		
Alternator	C071047 (12V) or C071048 (24V)		
Fuel Injection Pump	C02908	C02909	C02910
Heat Exchanger	C05804		
Starter Motor (12V)	C071944 or C071072		
Starter Motor (24V)	C071937 or C071074		
Switch, Oil Pressure	C071273 OR C071884		
Switch, Speed	C071001		
Switch, Coolant Temperature	C125678 OR C071881		
Turbocharger	C061643	C061644	C061645
Thermostat	C052059		
Nozzle, Injector	C02894		C02895